

ZD410

Desktop Printer



ZEBRA

User Guide

2022/12/27

ZEBRA and the stylized Zebra head are trademarks of Zebra Technologies Corporation, registered in many jurisdictions worldwide. All other trademarks are the property of their respective owners. ©2022 Zebra Technologies Corporation and/or its affiliates. All rights reserved.

Information in this document is subject to change without notice. The software described in this document is furnished under a license agreement or nondisclosure agreement. The software may be used or copied only in accordance with the terms of those agreements.

For further information regarding legal and proprietary statements, please go to:

SOFTWARE: zebra.com/linkoslegal.

COPYRIGHTS: zebra.com/copyright.

PATENTS: ip.zebra.com.

WARRANTY: zebra.com/warranty.

END USER LICENSE AGREEMENT: zebra.com/eula.

Terms of Use

Proprietary Statement

This manual contains proprietary information of Zebra Technologies Corporation and its subsidiaries ("Zebra Technologies"). It is intended solely for the information and use of parties operating and maintaining the equipment described herein. Such proprietary information may not be used, reproduced, or disclosed to any other parties for any other purpose without the express, written permission of Zebra Technologies.

Product Improvements

Continuous improvement of products is a policy of Zebra Technologies. All specifications and designs are subject to change without notice.

Liability Disclaimer

Zebra Technologies takes steps to ensure that its published Engineering specifications and manuals are correct; however, errors do occur. Zebra Technologies reserves the right to correct any such errors and disclaims liability resulting therefrom.

Limitation of Liability

In no event shall Zebra Technologies or anyone else involved in the creation, production, or delivery of the accompanying product (including hardware and software) be liable for any damages whatsoever (including, without limitation, consequential damages including loss of business profits, business interruption, or loss of business information) arising out of the use of, the results of use of, or inability to use such product, even if Zebra Technologies has been advised of the possibility of such damages. Some jurisdictions do not allow the exclusion or limitation of incidental or consequential damages, so the above limitation or exclusion may not apply to you.

Contents

About.....	9
Notational Conventions.....	9
Icon Conventions.....	10
Introduction.....	11
ZD410 Direct Thermal Printers.....	11
ZD410 Printer Features.....	11
ZD410 Printer Options.....	13
Zebra Label Printing Solution.....	14
Modes of Printing.....	14
What's in the Box?.....	15
Unpack and Inspect the Printer.....	15
Your Printer.....	16
Opening the Printer.....	20
Closing the Printer.....	20
Operator Controls.....	21
Battery Indicators and Controls.....	25
Zebra Print Touch.....	27
Install Hardware Options.....	29
Printer Connectivity Modules.....	29
Update Printer Firmware to Complete the Options Installation.....	30
Power Failure Recovery Mode Jumper (OFF by Default).....	30
Accessing the Connectivity Module Slot.....	30
Installing the Serial Port Module.....	31

Installing the Internal Ethernet (LAN) Module.....	32
Removing the Printer Connectivity Modules.....	33
Media Handling Options.....	33
Removing the Standard Bezel.....	34
Installing the Label Dispenser.....	34
Installing the Cutter.....	35
Media Roll Core Size Adapters.....	36
Installing the Attached Battery Base Option.....	38
Installing the Battery into the Attached Battery Base.....	39
Update Printer Firmware to Complete the Options Installation.....	42
Setup.....	43
Setting up the Printer – Process Overview.....	43
Select a Location for the Printer.....	45
Install Printer Options and Connectivity Modules.....	46
Attaching Power.....	46
Get Ready to Print.....	47
Prepare and Handle Media.....	47
Media Storage Tips.....	48
Roll Media Sensing and Media Loading.....	48
Interface Cable Requirements.....	60
USB Interface.....	60
Serial Interface.....	60
Ethernet (LAN, RJ-45).....	61
Setup for Windows PC or Other Device Communications.....	64
Connecting Your Printer to a Device.....	64
Connect to a Phone or Tablet.....	65
Setting up Windows to Printer Communication (Overview).....	65
Wi-Fi and Bluetooth Classic Wireless Connectivity Option.....	72
Set Up the Wi-Fi Print Server Option.....	73
ZebraNet Bridge’s Connectivity Wizard.....	73
After Your Printer is Connected.....	85

Test Communications by Printing.....	85
What To Do If You Forget to Install the Printer Drivers First.....	87
Print Operations.....	94
Thermal Printing.....	94
Determine Your Printer’s Configuration Settings.....	94
Replace Supplies.....	94
Detect a Media Out Condition.....	95
Recovering from a Media Out condition.....	95
Select a Print Mode.....	95
Print Modes.....	95
Adjust the Print Quality.....	96
Darkness Control.....	96
Printing on Fanfold Media.....	97
Print with Externally-Mounted Roll Media.....	99
Externally-Mounted Roll Media Considerations.....	100
Using the Label Dispenser Option.....	100
Print with the Attached Battery Base and Battery Option.....	105
Using UPS Mode.....	106
Using the Printer in Battery Mode.....	106
Send Files to the Printer.....	106
Printer Fonts.....	106
Identify Fonts in Your Printer.....	107
Localize the Printer with Code Pages.....	107
Asian Fonts and Other Large Font Sets.....	107
Get Asian Fonts.....	108
EPL Line Mode – Direct Thermal Printers only.....	108
Zebra ZKDU Printer Accessory.....	108
ZBI 2.0 — Zebra Basic Interpreter.....	109
Updating Printer Firmware.....	109
Setting the Power Failure Recovery Mode Jumper.....	110
USB Host Port and Link-OS Usage.....	111

Use a USB Host for Printer Firmware Updates.....	111
Preparing Flash Drive and Updating Firmware.....	112
USB Host and Printer Usage Examples.....	112
Items Required for the USB Host Exercises.....	112
Files for Completing the Exercises.....	113
Exercise 1: Copying Files to a USB Flash Drive and Performing USB Mirror.....	114
Use the USB Host Port and the NFC Capabilities.....	116
Exercise 2: Entering Data for a Stored File with a Smart Device and Printing a Label.....	116
Maintenance.....	119
Clean the Printer.....	119
Recommended Cleaning Supplies.....	119
Get Zebra Supplies and Accessories for Cleaning Your Printer.....	120
Recommended Cleaning Schedule.....	120
Cleaning the Printhead.....	121
Cleaning the Media Path.....	122
Options for Cleaning the Cutter and Label Dispenser.....	123
Cleaning the Sensors.....	125
Cleaning and Replacing the Platen (Drive Roller).....	126
Other Printer Maintenance.....	128
Real-Time Clock (RTC) Battery.....	129
No Replaceable Fuses.....	129
Replace the Printhead.....	129
Removing the Printhead.....	129
Replacing the Printhead.....	131
Troubleshooting.....	133
Resolve Alerts and Errors.....	133
Resolve Print Issues.....	135
Resolve Communication Issues.....	136
Resolve Miscellaneous Issues.....	138

Tools.....	140
Printer Diagnostics.....	140
Power-On Self Test.....	140
Activating SmartCal Media Calibration.....	141
Printing the Printer Configuration Report (CANCEL Self Test).....	141
Network and Bluetooth Configuration Report.....	143
Printing a Print Quality Report (FEED Self-Test).....	144
Resetting Non-Network Printer Configuration Settings to their Factory Defaults.....	147
Resetting the Printer's Network Settings to Their Factory Defaults.....	148
Reset Button Functions.....	148
Performing a Communication Diagnostics Test.....	149
Sensor Profile.....	150
Activating Advanced Mode.....	151
Manually Calibrating Media.....	151
Manual Print Width Adjustment.....	152
Manual Print Darkness Adjustment.....	153
Factory Test Modes.....	155
Interface Connector Wiring.....	156
Universal Serial Bus (USB) Interface.....	156
Serial Port Interface.....	157
Dimensions.....	159
Media.....	164
Types of Thermal Media.....	164
Performing a Media Scratch Test.....	164
General Media and Print Specifications.....	165
ZPL Configuration.....	168
ZPL Printer Configuration.....	168
ZPL Printer Configuration Format and Reusable Files.....	168
Configuration Setting to Command Cross-reference.....	169

Printer Memory Management and Related Status Reports..... 173
ZPL Programming for Memory Management.....173

About

This guide is for integrators and operators of Zebra Link-OS ZD410 desktop printers. Use this guide to install, change configuration, operate, and maintain these printers.

Other online resources are available to support this printer include:

- How-to videos
- Link to printer specifications
- Printer accessory, supplies, parts, and software links
- Various setup and configuration guides
- Programmer's manuals
- Printer drivers (Windows, Apple, OPOS, etc.)
- Printer firmware
- Printer fonts
- Utilities
- Knowledge base and support contacts
- Warranty and repair links

Use this link to access online support resources for your printer: zebra.com/zd410d-info

Notational Conventions

The following conventions are used in this document:

- **Bold** text is used to highlight the following:
 - Dialog box, window, and screen names
 - Drop-down list and list box names
 - Checkbox and radio button names
 - Icons on a screen
 - Key names on a keypad
 - Button names on a screen

- Bullets (•) indicate:
 - Action items
 - List of alternatives
 - Lists of required steps that are not necessarily sequential.
- Sequential lists (for example, those that describe step-by-step procedures) appear as numbered lists.

Icon Conventions

The documentation set is designed to give the reader more visual clues. The following graphic icons are used throughout the documentation set. These icons and their associated meanings are described below.



NOTE: The text here indicates information that is supplemental for the user to know and that is not required to complete a task.



IMPORTANT: The text here indicates information that is important for the user to know.



CAUTION—EYE INJURY: Wear protective eyewear when performing certain tasks such as cleaning the inside of a printer.



CAUTION—EYE INJURY: Wear protective eyewear when performing certain tasks such as installing or removing E-rings, C-clips, snap rings, springs, and mounting buttons. These parts are under tension and could fly off.



CAUTION—PRODUCT DAMAGE: If the precaution is not taken, the product could be damaged.



CAUTION: If the precaution is not heeded, the user could receive a minor or moderate injury.



CAUTION—HOT SURFACE: Touching this area could result in burns.



CAUTION—ESD: Observe proper electrostatic safety precautions when handling static-sensitive components such as circuit boards and printheads.



CAUTION—ELECTRIC SHOCK: Turn off (O) the device and disconnect it from the power source before performing this task or task step to avoid the risk of electric shock.



WARNING: If danger is not avoided, the user CAN be seriously injured or killed.



DANGER: If danger is not avoided, the user WILL be seriously injured or killed.

Introduction

This section introduces you to your new Zebra ZD410 desktop thermal label printer.

ZD410 Direct Thermal Printers

The Zebra ZD410 models are desktop label printers with the widest range of features and options. When connected to a host computer, your printer functions as a complete system for printing labels, tags, tickets, wrist bands, and receipts.

- The 203 dpi (dots per inch print density) version of this printer provides direct thermal printing at speeds up to 152.4 mm/s (6 inches per second or ips).
- The 300 dpi printer version of this printer provides direct thermal printing at speeds up to 101.6 mm/s (4 ips).
- ZD410 Healthcare printer models have plastic exteriors to withstand common hospital cleaning chemicals. They ship with a medical grade power supply.

These printers support both ZPL and EPL Zebra printer programming languages and a wide variety of printer options.

ZD410 Printer Features

The features of your printer include:

High-quality printing capability	Provided on a small footprint device.
OpenAccess design	For simplified media loading.
Media handling options	Designed for ease of field installation.
Support for media rolls	Sized up to: <ul style="list-style-type: none">• an outer diameter (O.D.) of up to 127 mm (5 in.)• an inner diameter (I.D.) of 12.7 mm (0.5 in.) / 25.4 mm (1 in.)  NOTE: Your printer also supports other core sizes when the rolls are used with (optional) media core adapters.
Movable sensor compatible with a wide range of media types	Supports black mark media (full or partial width), notched media, slotted media, and label gap/web media (using multi-center position transmissivity sensing).

Color-coded touchpoints	For operator controls and media guides for ease of use.
Enhanced user control panel	Feature three buttons and five status indicators.
Universal Serial Bus (USB) host port and USB 2.0 interface	For ease of firmware updates.
Modular connectivity slot	For field installable Ethernet (802.3 RJ-45) or Serial interface options
Backward-compatibility focused technology	To make it easy to replace your printers: <ul style="list-style-type: none"> • Drop-in replacement of legacy Zebra desktop printers. • Support for both EPL and ZPL programming languages. • To support EPL1 legacy print programming applications, support in the 203 dpi printer models for line-mode printing. • For the interpretation of non-Zebra printer programming language commands, support for Link-OS virtual devices.
Font support	On-the-fly OpenType and TrueType font scaling and import, Unicode, resident scalable font (Swiss 721 Latin 1 font), and a selection of resident bitmap fonts.
XML-enabled printing	Allows XML communications for barcode label printing, which eliminates license fees and the need for print server hardware, while also lowering customization and programming costs.
Zebra Global Printing Solution	Support for: <ul style="list-style-type: none"> • Microsoft Windows keyboard encoding (and ANSI) • Unicode Transformation Formats UTF-8 and UTF-16 • XML • ASCII (7-bit and 8-bit used by legacy programs and systems) • Basic single- and double-byte font encoding • JIS and Shift-JIS (Japanese International Standards) • Hexadecimal encoding, and • Custom character mapping (DAT table creation, font linking, and character remapping).
Factory-installed network models	Enables printer configuration with a setup utility running on mobile devices. Uses optional Bluetooth Low Energy (LE) feature for short-range communication to a variety of mobile devices.  NOTE: Bluetooth LE is compatible with Zebra mobile setup utility applications to enable printer setup, print media calibration, and print quality maximization.
Zebra's Print Touch (Near Field Communication or NFC)	Enables tapping and pairing of devices with your printer, accessing printer information, and connectivity with mobile applications.

Zebra Link-OS	An open platform which connects smart Zebra device operating systems with powerful software apps, making the devices easy to integrate, manage, and maintain from any location.
User accessible flash memory	72 MB (64 MB E : memory) for storing forms, fonts, and graphics.
Printhead maintenance reporting	To easily manage the printhead.
No-tool replacement	For the printhead and the platen (drive) roller.

ZD410 Printer Options

Several optional components are available for your printer.

Healthcare printer models	<ul style="list-style-type: none"> Plastic surfaces for easy disinfecting and cleaning IEC 60601-1 certified power supply
Factory-installed wired and wireless networking options	<p>With an on-board Real Time Clock (RTC) included for these factory-installed options:</p> <ul style="list-style-type: none"> Bluetooth Low Energy (LE) wireless connectivity Wi-Fi (802.11ac—includes a/b/g/n), Bluetooth Classic 4.x (3.x compatible), and Bluetooth LE wireless connectivity Factory-installed internal Ethernet print server (LAN, RJ-45 connector)—Supports 10Base-T, 100Base-TX, and fast Ethernet 10/100 auto-switching networks for wired connectivity.
Field-installable connectivity modules	<ul style="list-style-type: none"> Internal Ethernet print server (LAN, RJ-45 connector)—Supports 10Base-T, 100Base-TX, and fast Ethernet 10/100 auto-switching networks <p> NOTE: The above option does not include the Real-Time Clock (RTC) feature that comes with the factory-installed wired and wireless options.</p> <ul style="list-style-type: none"> Serial (RS-232 DB-9) port
Field-installable media handling options	<ul style="list-style-type: none"> Label dispenser (peels off liner before dispensing the printed labels) General purpose media cutter
Media core adapter kits	For 38.1 mm (1.5 in.), 50.8 mm (2.0 in.), or 76.2 (3.0 in.) inner diameter (I.D.) media cores
Attached battery base with removable battery (sold separately)	<ul style="list-style-type: none"> Constant regulated 24 VDC provided by the battery to maintain print quality until the battery shuts down (when it needs a recharge), to maintain printing quality during jobs Shutdown mode for shipping and storage Built-in battery charge and status indicators

Asian Language support with printer configuration options for large Simplified and Traditional Chinese, Japanese, or Korean character sets	 NOTE: Printers sold in China have the Simplified Chinese SimSun font pre-installed.
Zebra ZBI 2.0 (Zebra BASIC Interpreter) programming language	Allows you to program custom printer operations to automate processes and use peripheral devices (such as scanners, scales, keyboards, Zebra ZKDU, etc.) without having to connect the printer to a PC, device, or network.

Zebra Label Printing Solution

The printer is just one of three parts of a printing solution. To print, you need your printer, compatible direct thermal media, and software (driver, applications or programming) to instruct the printer on what to do and what to print.

The media you need may be labels, tags, tickets, receipt paper, fanfold stacks, tamper-proof labels, etc.

The printer setup cannot be completed without media installed. Ideally, your chosen media should be the same media used for its intended operation. Starting with your chosen media will speed printer setup and deployment.

Zebra assists you with label design and print with the free label and form design software. See zebra.com/zebradesigner for details on ZebraDesigner for Windows PC operating systems.

Zebra provides a complete suite of free Link OS software applications and drivers to configure printer settings, print labels and receipts, get printer status, import graphics and fonts, send programming commands, update firmware, and download files. See zebra.com/linkos for details.

Use the information on the Zebra web site at zebra.com/supplies or contact your reseller for help identifying the appropriate media for your use.

Modes of Printing

You can operate your ZD410 printer in various modes and media configurations:

Direct thermal printing	Uses heat sensitive media to print.
Standard tear-off mode	Allows you to tear off each label/receipt (or batch print a strip of labels) after it is printed.
Label dispense mode	if an optional dispenser is installed, the backing material can be peeled away from the label as it is printed. After this label is removed, the next one is printed.
Media cutting	If an optional media cutter is installed, the printer can cut the label liner between labels, receipt paper, or tag stock.
Standalone	The printer can print without being connected to a computer, using the printer's auto-running label form feature (programming based) or by using a data input device connected to the printer's serial port. This mode accommodates data input devices, such as scanners, weigh scales, or a Zebra Keyboard Display Unit (ZKDU).

Shared network printing	Printers configured with an Ethernet (LAN) and Wi-Fi interface options include an internal print server.
-------------------------	--

What's in the Box?

After unpacking, make sure you have all items shown below. Follow the procedures for inspecting the printer to familiarize yourself with your printer interfaces and components.



Printer



USB cable



Printer documentation



Power supply



Power cord (varies by region and locale)

Unpack and Inspect the Printer

When you receive the printer, immediately unpack it and inspect the contents of the box for shipping damage.

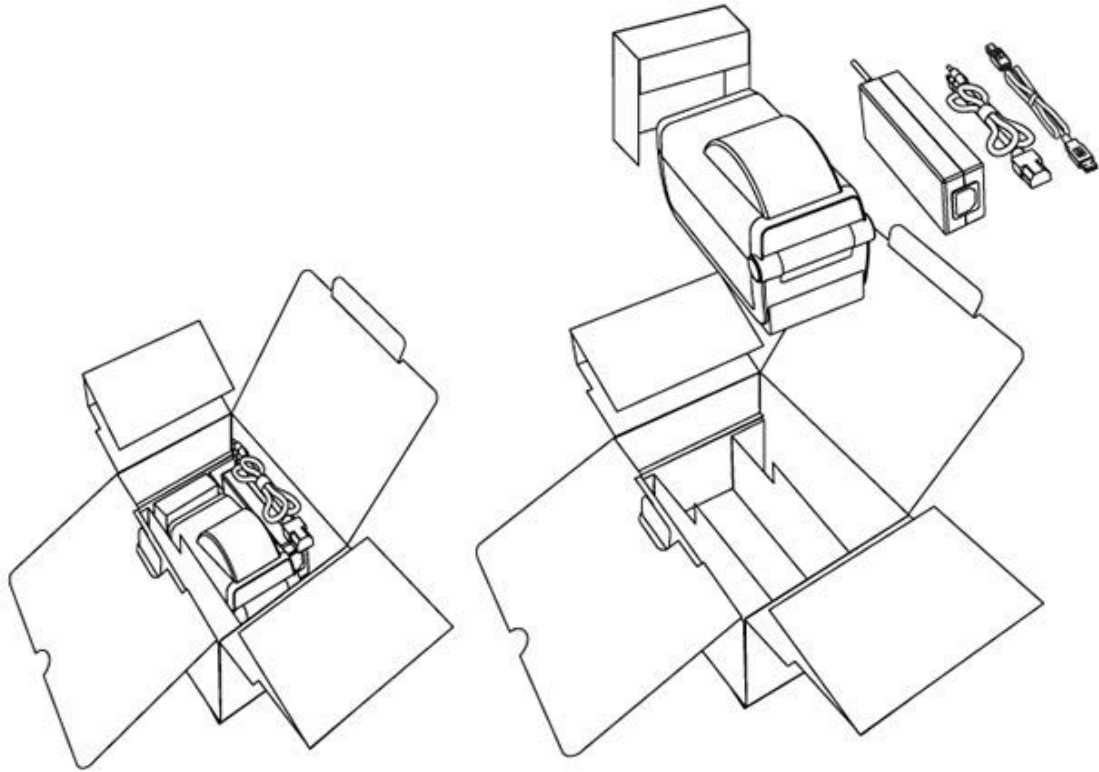

Be sure to:

- Save all packing materials.
- Check all exterior surfaces for damage.
- Open the printer and inspect the media compartment for damage to components.

If you discover shipping damage upon inspection:

- Immediately notify the shipping company and file a damage report.



NOTE: Zebra Technologies is not responsible for any damage to the printer incurred during shipment, and will not cover the repair of this damage under its warranty policy.

- Keep all packaging material for shipping company inspection.
- Notify your authorized Zebra reseller.

See zebra.com/zd410d-info for videos on how to unpack and pack your printer.

Your Printer

Familiarize yourself with the external and internal features of your printer and the locations of the user interface controls.



NOTE: Depending on the printer model and the installed options, your printer may look slightly different.



1	Control panel
2	Release latches



1	Power switch
2	Fanfold media entry slot
3	Internet and connectivity module slot access

4	DC power receptacle
---	---------------------

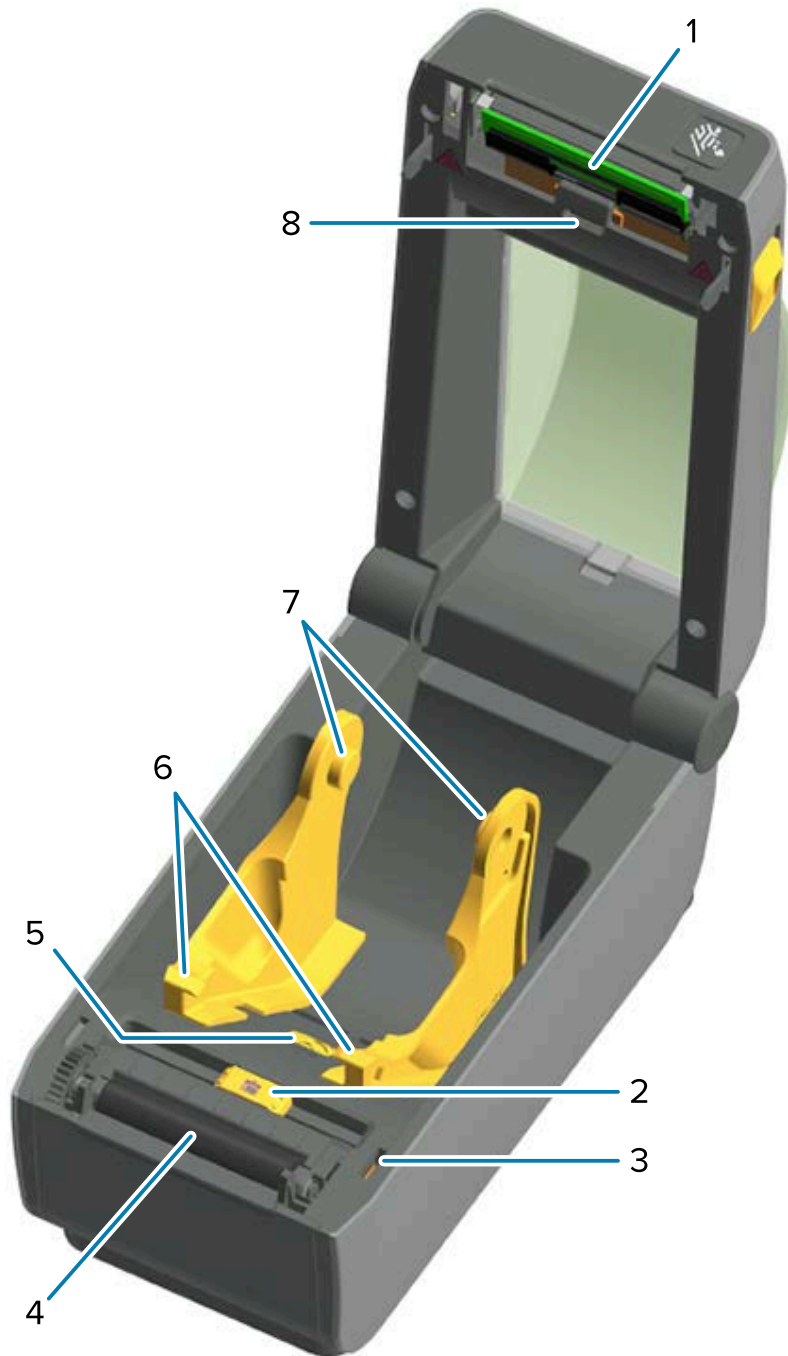

1	Printhead
2	Movable sensor (black mark and lower web/gap)
3	Head-up sensor (inside)
4	Platen (drive) roller

5	Media guide stop adjustment
6	Media guides
7	Roll holders
8	Upper web (gap) array sensor

Figure 1 Label Dispenser Option (field installable)

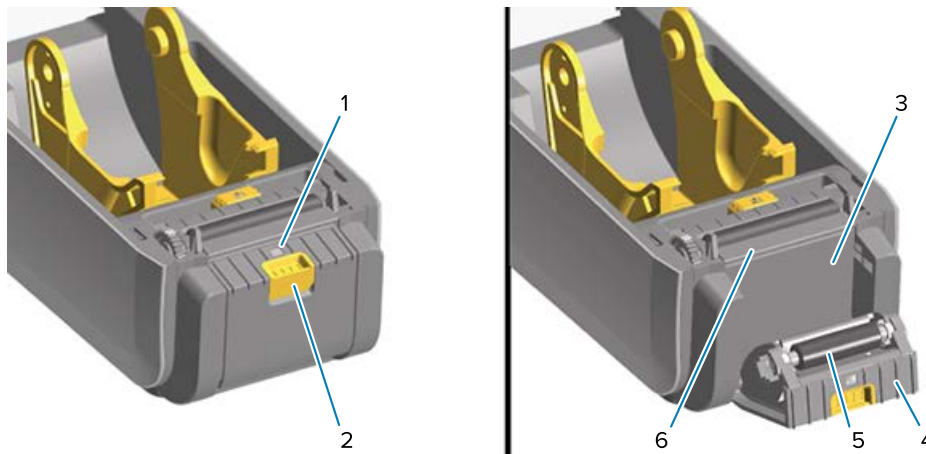

1	Label-taken sensor
2	Door latch
3	Label liner exit area
4	Dispenser door
5	Peel roll
6	Label peel bar

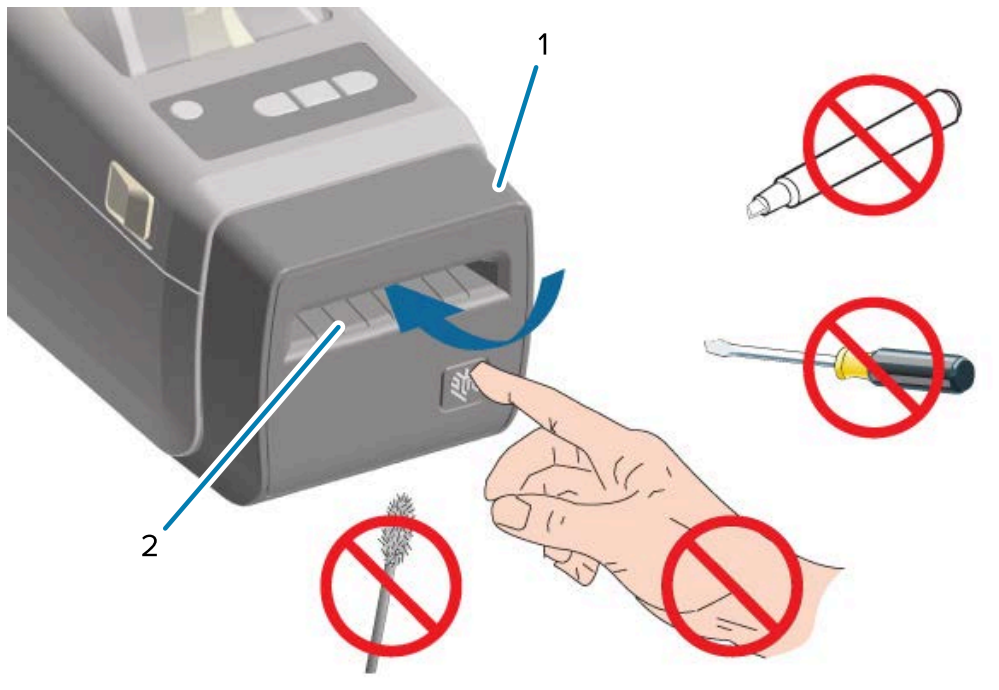
Figure 2 Cutter Option (field installable)

1	Cutter module
2	Media exit slot

Opening the Printer

You will need to open the printer and access its media compartment for routine printer operations such as loading media and cleaning the compartment.

Pull the release latches towards you and lift the cover.



CAUTION: Observe proper electrostatic safety precautions when handling static-sensitive components such as circuit boards and printheads to avoid personal injury or damage to printer components.

Closing the Printer

1. Lower the top cover.

2. Press down in the middle of the cover in front until the cover snaps closed.

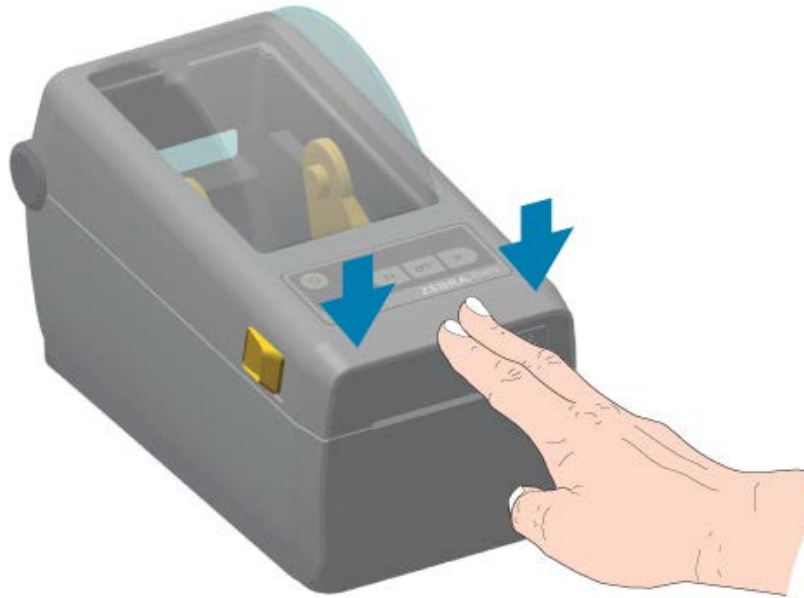







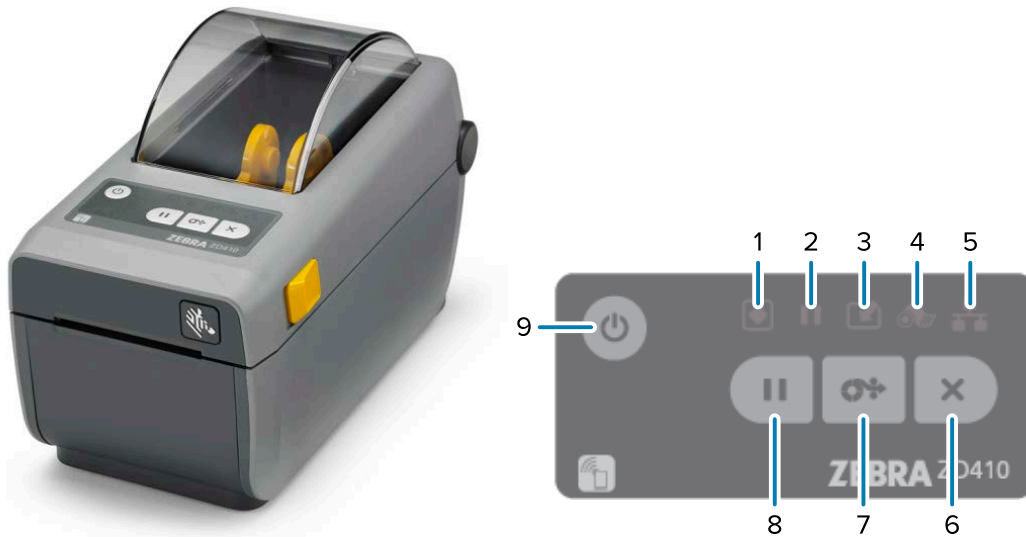

Operator Controls

The printer's primary user interface controls are on the front of the device.

Depending on the state of the printer, the printer indicators may be off (not lit) or they may light up red, green, or yellow—either blinking or lighting up steady in a variety of patterns—to convey the printer's status and activities. See [Resolve Alerts and Errors](#) on page 133.







1		Status indicator
---	---	------------------

2		Pause indicator
3		Data indicator
4		Supplies indicator
5		Network indicator
6		CANCEL button
7		FEED (Advance) button
8		PAUSE button
9		POWER button





 (**POWER** button) — Used to turn printer power ON and OFF, and to initiate low power sleep and wake states described below.

 **IMPORTANT:** Be sure to turn printer power OFF before you connect or disconnect all communication interface and power cables. Printer power must be switched OFF when installing the printer driver.

Initial Power-On Mode	<p>Press POWER to apply power to the printer.</p> <p>The printer indicator lights flash in various combinations for several seconds as the printer starts up, performs self-diagnostics and configuration checks, and integrates optional components if any are installed.</p> <p>The Status Indicator turns solid Green. The printer is now ready to print.</p>
Sleep Mode	<p>Press and release POWER once to place the printer in Sleep mode.</p> <p>The printer turns off after storing various configuration and status information in memory. All the indicators are off except for the Status indicator which slowly lights on and off to indicate that the printer is in Sleep mode.</p>
Power Off with Sleep Mode Delayed	<p>This mode enables you to start a batch print job and put the printer into a low power consumption state (Sleep mode) after the job is done printing. Press and hold POWER for 4 to 9 seconds to enter this mode.</p>
Power Off (shutdown)	<p>To turn printer power OFF, press and hold POWER for 4 to 9 seconds.</p>

Power Failure Recovery Mode (supports two modes: Sleep Mode and Power Off, and Sleep Mode Delayed)	Power Failure Recovery Mode is available ONLY on printers that have an (optional) printer connectivity module installed. To activate this mode, see Setting the Power Failure Recovery Mode Jumper on page 110). When this mode is activated, the printer automatically powers ON when plugged into an active AC power source.
 (CANCEL button) — Pressing this button cancels print jobs.	
To cancel printing the next format (label, tag, etc.) in the print buffer...	Press CANCEL one time.
To cancel the printing of ALL pending formats (labels, tags, etc.) in the print buffer...	Press and hold CANCEL for two seconds.
 (FEED/Advance button) — Advance a label (print form/format).	
To feed a single label (i.e., advance the media one blank form/format length of label, receipt, tag, ticket, etc.)...	Wait for the printer to stop printing, then press and release FEED .
To reprint the last label...	Use the SGD command <code>ezpl.reprint_mode</code> .  NOTE: If the printer is turned off or is reset during a print operation, any jobs received and stored in the print buffer will be fully cleared. To avoid the loss of the job if a label fails to print, send the <code>ezpl.reprint_mode</code> command to the printer.
 (Pause button) — Pressing this button pauses all printing and media movement.	
To stop print activities and place the printer into a Pause' mode...	Press PAUSE . The printer completes printing the label being printed and then enters Pause mode. The Pause indicator lights up Amber (orange/yellow) to indicate Pause mode.
To return the printer to normal operation after being placed in Pause mode...	Press PAUSE . If the printer was in the middle of a multi-label (form/format) print job—or if it is had another print job waiting in queue before you placed it in Pause mode—it exits Pause mode and resumes printing.
 (Printer Status and Power indicator) — Denotes overall printer health and operational status.	
Green	The printer is ready to receive data and print.

Introduction

Green, slowly and continuously turning on and off	The printer is in Sleep mode.
Red	<ul style="list-style-type: none"> • The printer is out of media. • The printer encountered an error when trying to detect media. • The printer cover or printhead is open. • Printhead authentication failed.
Amber	<ul style="list-style-type: none"> • Detected a printhead over temp (temperature) condition. • A printhead element failed. • The printer is out of memory to store additional content (formats, graphics, fonts, etc.). • A power fault was encountered for the USB Host/Serial port(s).
Amber, blinking	Detected a printhead under temp (temperature) condition.
Red, blinking (for both the Status indicator and the Pause indicator)	Detected a printhead over temp (temperature) condition. Wait for the printhead to cool, then restart the printer.
 (Pause indicator) — When this indicator is lit, it denotes that the printer is in Pause mode. In Pause mode, you can press Cancel to cancel one or more labels (print forms) in the print queue.	
Amber	<p>The printer is paused.</p> <p>All printing, label feed/advance, and other label printing routines are suspended.</p> <p>To exit the printer from Pause mode and resume print operations, press PAUSE.</p>
Red, blinking (for the Status indicator and the Pause indicator simultaneously)	Indicates a printhead over temp (temperature) state. Wait for the printhead to cool, then restart the printer.
 (Data indicator) — Indicates data transfer activity status.	
Off	Data not being transferred.
Green	Data communication operation has not completed, but data is not actively being transferred.
Green, blinking	Data communication in process.
Amber, blinking	Out of memory while storing content (formats, graphics, fonts, etc.).
 (Supplies indicator) — Indicates media (label, receipt, tags, etc.) loading status.	
Red	The printer is out of media.
 (Network indicator) — Indicates network activity and status.	

Amber	Detected 10-base Ethernet (LAN) connection.
Amber, blinking	Wi-Fi (WLAN) authentication in process.
Green	Detected 10/100 Ethernet (LAN) connection or strong Wi-Fi (WLAN) signal and connection.
Green, blinking	Connected to Wi-Fi (WLAN) with a weak signal.
Red	Detected faulty Ethernet (LAN) or Wi-Fi (WLAN) connection.
Red, blinking	Associating with Wi-Fi (WLAN).

Battery Indicators and Controls

The optional printer battery accessory has a simple, one-button, four LED indicator light user interface to control and display battery status and health. The battery acts as a UPS (uninterruptible power supply) for the printer. For more information on using the battery and using power-saving modes (sleep, shutdown, etc.), see [Print with the Attached Battery Base and Battery Option](#) on page 105.

Figure 3 Rear of Battery

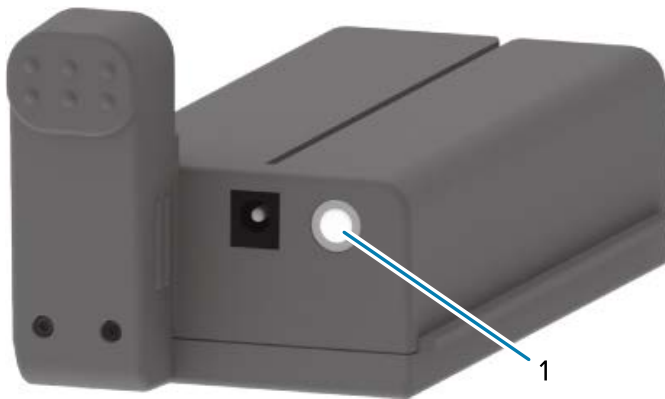

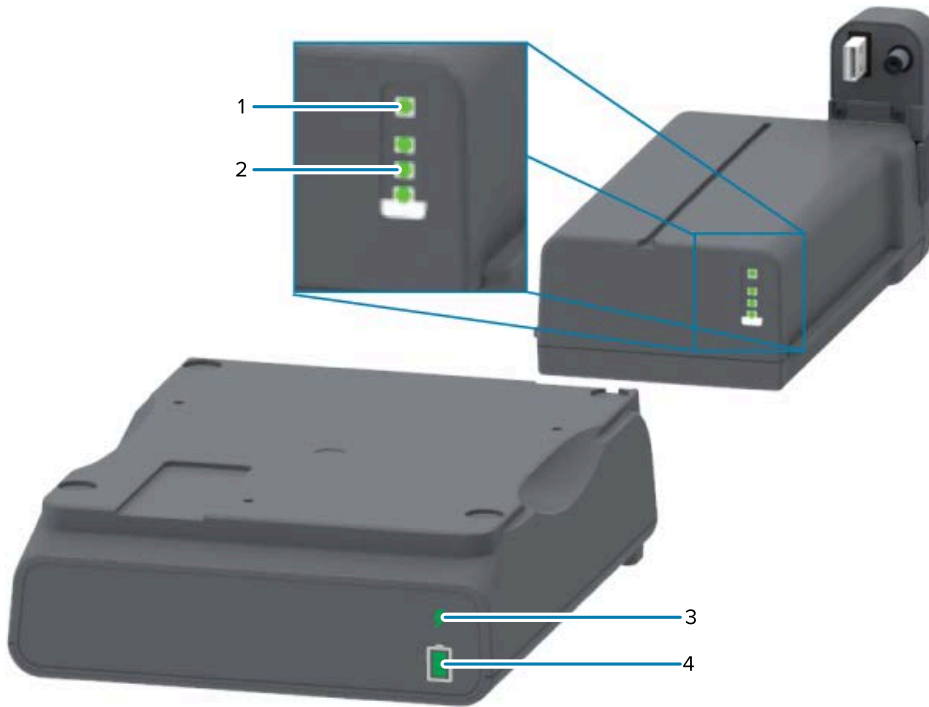

1	Battery Control button
---	-------------------------------

Figure 4 Front of Battery



1	Health indicator
2	Charge level indicators (3)
3	Health indicator
4	Charge level indicators (3)

 (Battery Control button) – Used to manage the batteries inside and outside the printer.	
To apply power to the battery...	Press and release Battery Control . Wakes up the battery from Sleep mode or Shutdown mode by applying power. The battery self-checks health and charge status, and displays the level of battery charge for 10 seconds immediately after the internal battery health checks are complete. The battery indicators all flash on and off together three times. At this point, you have one minute to turn printer power ON, by pressing the printer's POWER button. If the button is not pressed within that timeframe, the battery returns to Sleep mode or Shutdown mode.
To enter Shutdown Mode...	Press and hold Battery Control for 10 – 11 seconds and release. The battery begins to shut down. Approximately three seconds later, all battery LEDs flash three times to indicate that the battery has shut down.

 (Battery Health Indicator) — Displays the battery's charging status and health of the battery.	
Green	Good health. Battery is fully charged and ready to operate.
Amber	Charging. Printer power is OFF.
Red	Battery has run into an internal error. Remove the battery and see Troubleshooting on page 133.
Red, flashing	Charging error—the battery is over or under temperature or there is an internal monitoring error or some other fault.
 (Battery Charge Level Indicator) — Displays the battery's charging status and health of the battery.	
Green, all three bars lighting steady	The battery is fully charged.
Green, two bars steady green with the top green bar flashing.	The battery is at less than full charge.
Green, one green bar flashing	It is time to charge the battery.
Amber	The battery is charging.
No bar is lit up.	The battery needs charging, but the Battery Health indicator flashes when Battery Control is pressed. The printer cannot be turned on. See Troubleshooting on page 133.

Zebra Print Touch

The Zebra Print Touch feature allows you to pair an Android-based device (such as a smartphone or tablet) which has Near Field Communication (NFC) enabled, by simply touching the device to the printer's Print Touch logo. After the devices are paired using NFC, you can use your Android-based device to supply information for which you are prompted and print a label using that information.

The Print Touch location can be found on the interface control panel of the printer on the lower left-hand side.



IMPORTANT: Some mobile devices may not support NFC communication with the printer until you configure the required NFC settings in your device. If you encounter difficulties, consult your service provider or your smart device manufacturer for more information.

Data encoded into the tag includes:

- a URL for a Zebra quick-help style support web page
- the printer's unique Bluetooth LE (Low Energy) MAC address
- the printer's Bluetooth Classic MAC address (if present)
- the printer's Wi-Fi (WLAN) MAC address (if present)
- the printer's Ethernet (LAN) MAC address (if present)
- the printer SKU (for example, ZD41022-D01W01EZ)
- the printer's unique serial number

The NFC tag can be used to:

- facilitate Bluetooth pairing with a compatible mobile device.
- launch an application.
- launch a mobile browser and access a web page.

Install Hardware Options

To simplify and speed up the setup process, install all connectivity modules and media handling options before setting up and using your printer for the first time.



IMPORTANT: It is strongly recommended that you update your printer's firmware after printer setup is complete. See [Update Printer Firmware to Complete the Options Installation](#) on page 30. Several of these hardware options have internal firmware that require an update to interface optimally with the firmware version installed on the printer's main logic board.

Printer Connectivity Modules

You must remove the connectivity module's access door to install the options listed below. See [Accessing the Connectivity Module Slot](#) on page 30:

- Serial (RS-232 DB-9) port (see [Installing the Serial Port Module](#) on page 31).
- Internal Ethernet (LAN, RJ-45 connector)—supports 10Base-T, 100Base-TX and fast Ethernet 10/100 auto-switching networks (see [Installing the Internal Ethernet \(LAN\) Module](#) on page 32).

Media Handling Options

You must remove the printer's standard bezel to install these options (see [Removing the Standard Bezel](#) on page 34):

- Label dispenser (peel-off liner and dispense label) (see [Installing the Label Dispenser](#) on page 34)
- General purpose media cutter (see [Installing the Cutter](#) on page 35.)
- Media roll adapters for 38.1 mm (1.5 in.), 50.8 mm (2.0 in.), or 76.2 mm (3.0 in.) inner diameter (I.D.) media cores (see [Installing Media Roll Adapters](#) on page 37)

Power Base Options

The direct thermal and thermal transfer versions of this printer can both be upgraded with power base field upgrade kits to add:

- Attached battery base (battery pack is sold separately)
- Battery (battery power base is sold separately)

Printer Connectivity Modules

The printer connectivity modules can be easily installed without the need for tools.



CAUTION—ESD: Observe proper electrostatic safety precautions when handling static-sensitive components such as circuit boards and printheads.

Update Printer Firmware to Complete the Options Installation

To ensure optimal printer performance, routinely update the printer's firmware with the latest version. See [Updating Printer Firmware](#) on page 109.

The most current instructions are available on the Zebra web site at zebra.com/support.

Power Failure Recovery Mode Jumper (OFF by Default)

All printer connectivity modules have a power failure recovery jumper which is set to the OFF position by default.

You can set the jumper to On to make the printer automatically power ON when it is plugged into an active AC power source. To activate the mode, see [Setting the Power Failure Recovery Mode Jumper](#) on page 110.



NOTE: Power Failure Recovery Mode is available ONLY on printers that have a printer connectivity module installed.

For detailed information on power ON and power OFF modes and behaviors, see [Operator Controls](#) on page 21: **POWER** Button: Power Failure Recovery Mode.

Accessing the Connectivity Module Slot

1. Open the module access door by pushing down on the top of the door with your fingertip.
This releases the latch.
2. Pull the door away and down to remove.

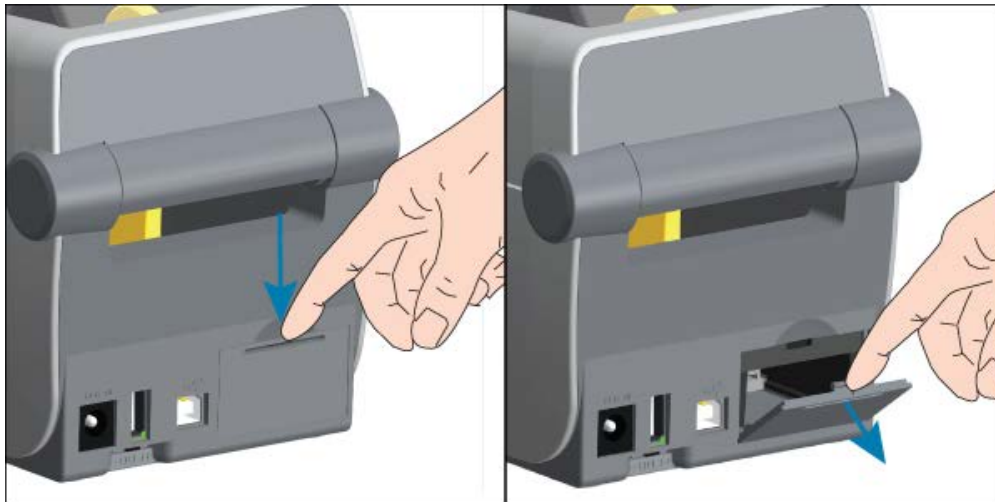

Installing the Serial Port Module

1. With the module's access door removed, slide the serial port module into the printer. Push the circuit card in slowly but firmly until the card is just past the inside lip of the access door.



2. Align the bottom of the serial port's door cover to the bottom lip of the module access opening. Swing the door up and snap the cover closed.



1	Serial Port (RS-232)
---	----------------------

Installing the Internal Ethernet (LAN) Module

1. With the module's access door removed, slide the Ethernet module into the printer. Push the circuit card in slowly but firmly until the card is just past the inside lip of the access door.



2. Align the bottom of the Ethernet port's door cover to the bottom lip of the module access opening. Swing the door up and snap the cover closed.



1	Ethernet port (RJ-45)
---	-----------------------

Removing the Printer Connectivity Modules

Connectivity modules can easily be removed to reconfigure or repair the printer hardware.



NOTE: You should not remove and replace connectivity modules as a general practice. It is not part of normal printer operations.

If you do have to remove the modules:

1. Unplug the Ethernet or serial interface cable from the printer.
2. Remove the module access door by pushing down on the top of the door with your finger tip to release the latch. Pull the door away and down to remove.
3. Re-attach the interface cable to the connectivity module and secure the cable.
4. Gently pull on the interface cable that is secured to the connectivity module. Slowly pull the module out of the printer.
5. Install a different connectivity module or re-install the connectivity module's access door. Align it to the bottom lip of the access opening and swing it up to snap and lock in place.

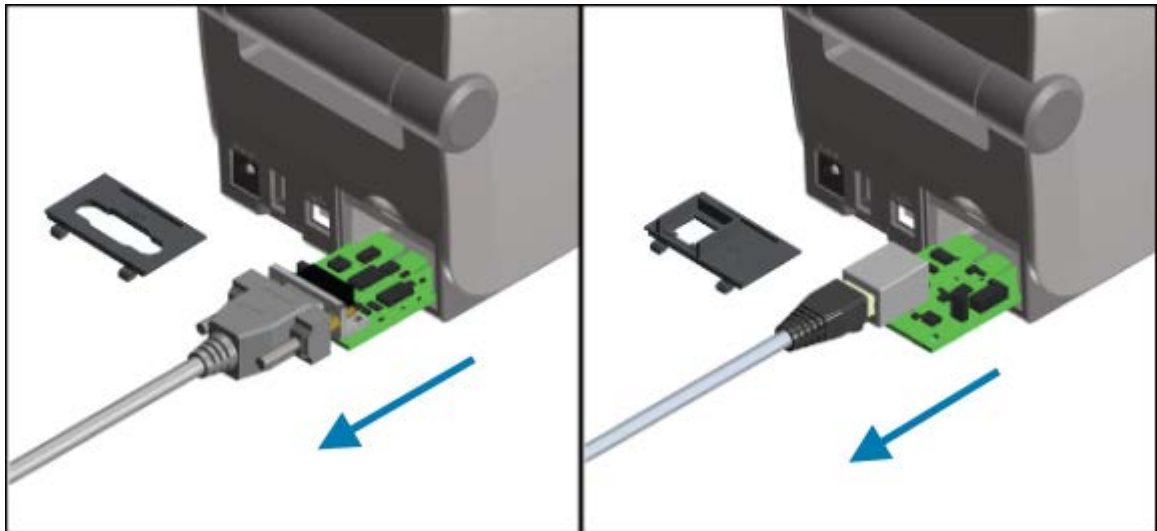

Media Handling Options

Zebra has designed easy-to-add media options so you can modify your printer to fit your use cases.

Media handling options and access parts are secured to the printer using two Torx T10 screws located on the bottom of the printer. A Torx Allen type wrench is provided.

After the media handling options are installed, the printer will verify any hardware changes and configure the printer to support those options during a restart.

Note the following with regard to the media handling options:

- These media options do not require removal for normal operation and cleaning.



NOTE: As a general practice, remove or replace the Media Handling options only when it becomes necessary (such as for essential repairs).

- The ZD Series Cutter options are self-cleaning by design and do not require internal cleaning with the use of Zebra media and supplies.

- The printer will not detect Media Roll Core Size Adapter addition or changes.



CAUTION—ESD: The discharge of electrostatic energy that accumulates on the surface of the human body or other surfaces can damage or destroy the printhead and other electronic components used in this device. Observe static-safe procedures when working with the printhead or the electronic components such as circuit boards under the top cover.

Removing the Standard Bezel

You must remove the standard bezel to mount your media handling option.

1. Turn the printer upside down. Remove the two mounting screws and save them so you can attach them later.
2. Slide the bezel down the front about 12.5 mm (0.5 in.) and pull the loose bezel out.

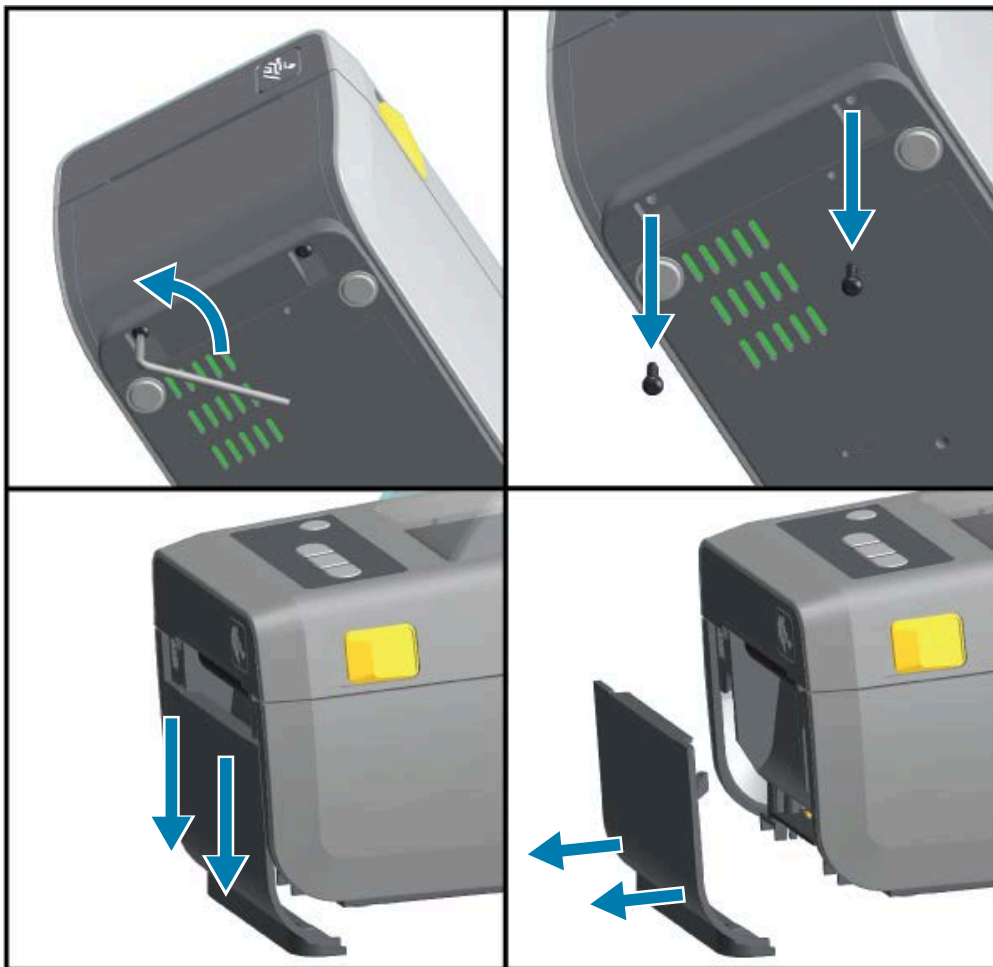

Installing the Label Dispenser

The standard bezel must be removed before the Label Dispenser can be installed.

1. Place the Label Dispenser module and printer right side up, with the top of the module 12.5 mm (0.5 in.) below the bottom of the top cover. Center and push the module into the front of the printer and slide it up until it stops.

2. Turn the printer upside down and attach the module to the printer with the two screws.

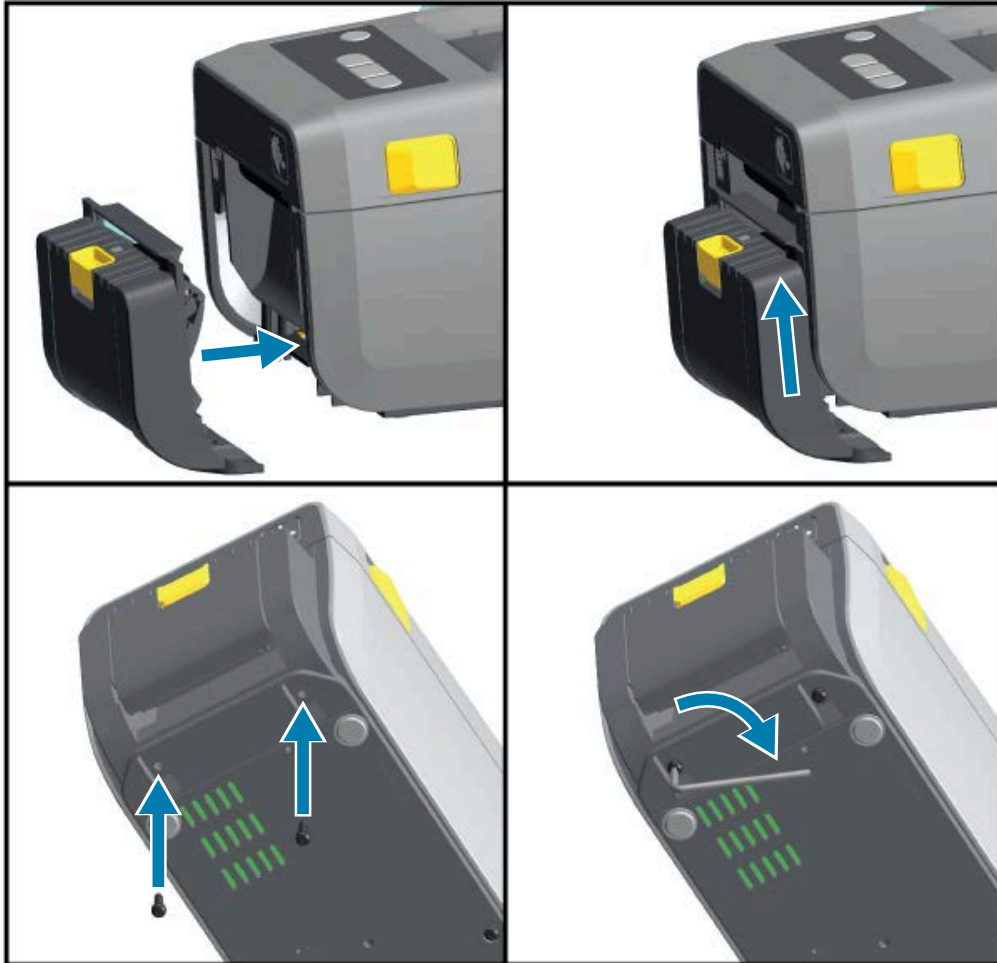

Installing the Cutter

The standard bezel must be removed before the Cutter module can be installed.

1. Place the Cutter module and printer right side up, with the top of the module even with the bottom of the top cover. Center and push the module into the front of the printer and slide it up until it stops.

2. Turn the printer upside down and attach the module to the printer with the two screws.

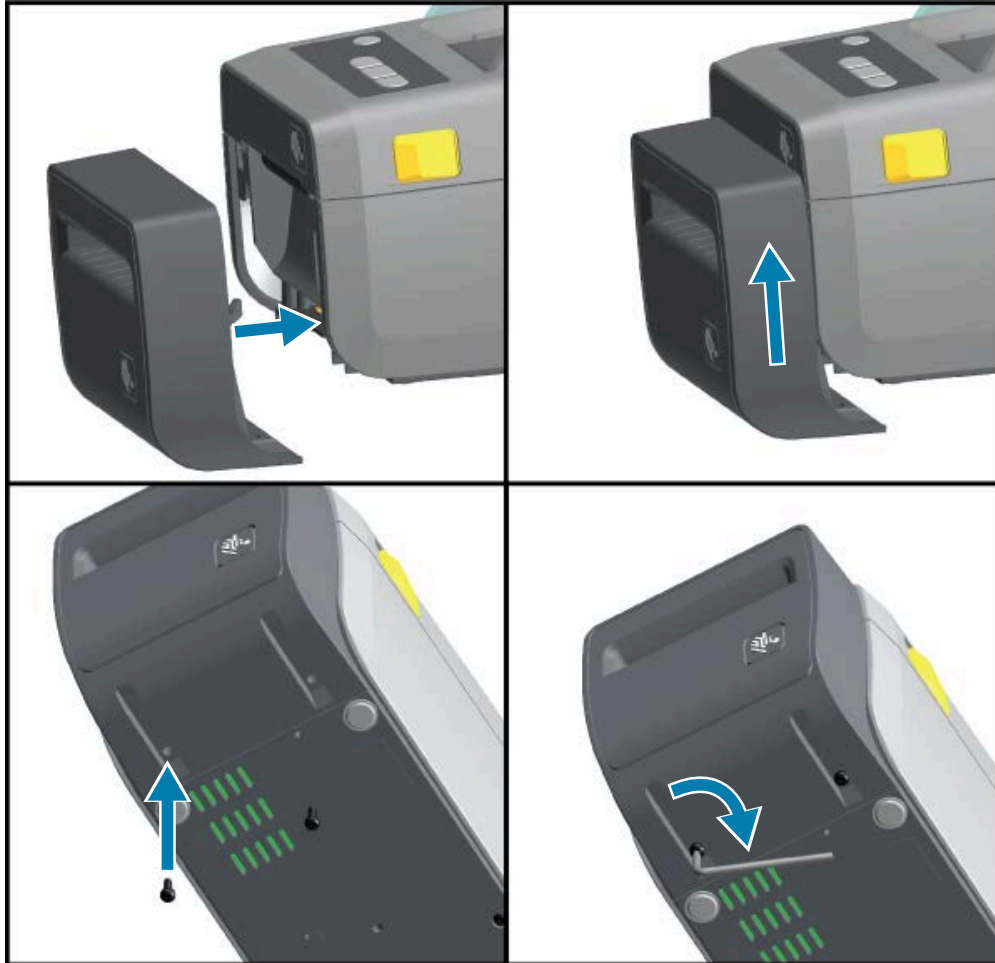

Media Roll Core Size Adapters

The media roll adapters kit includes three pairs of media roll adapters.

The three kits are for media cores with the following inner diameters (I.D.):

- 38.1 mm (1.5 in.)
- 50.8 mm (2.0 in.)
- 76.2 mm (3.0 in.)

The adapters are intended to be permanently installed in the printer. They may be changed to support other media roll sizes that require one of these adapter sizes.



NOTE: The adapters may wear out if they are changed too much.

When the media adapters are removed to print on standard roll cores, it may cause the media roll holder's plastic-piece side areas to rub against the roll. Push these attached pieces back into the side of the media roll holder.

Installing Media Roll Adapters

1. Place one screw in the top adapter mounting hole of both of the roll holders. Start turning the screws clockwise until the tip of the screw is just protruding through the inside of the roll holder. The screws are self-tapping.

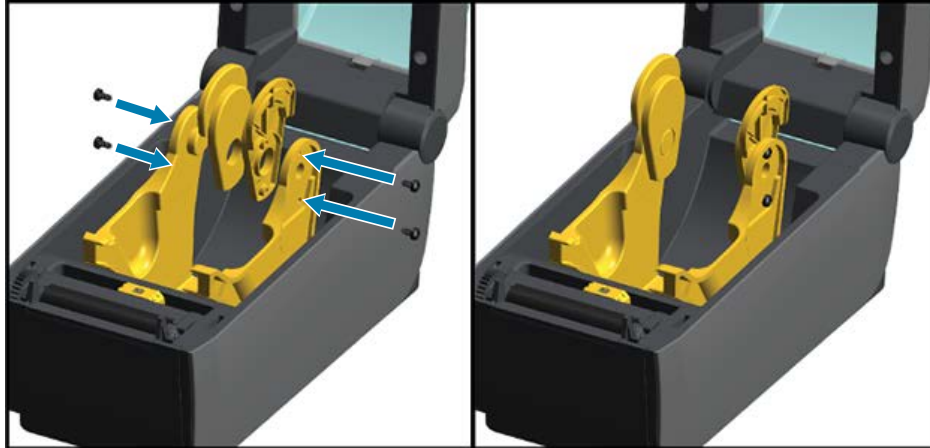

2. Place the adapter on the inside of the roll holder. The large side of the adapter is on top. The smooth side (no ribs) faces the middle of the printer.
3. Align the adapter's top screw hole to the protruding screw tip and pinch it tightly to the roll holder body. Tighten the screw until there is no gap between the adapter and roll holder.



NOTE: Do not tighten beyond this point. Over tightening will strip the thread.

4. Insert a screw in the bottom adapter mounting hole. Pinch the adapter tightly to the roll holder while tightening the screw. Tighten the screw until there is no gap between the adapter and roll holder.



NOTE: Do not tighten beyond this point. Over tightening will strip the thread.

5. Repeat steps 1 through 4 for the other adapter and roll holder.

Figure 5 Example of Label Roll with 76.2 mm (3.0 in.) Inner Core (I.D) and Media Core Adapters Attached



Installing the Attached Battery Base Option

The battery base ships ready to attach to the printer. It is installed using a Torx T10 wrench and the mounting screws provided as part of the upgrade kit.

1. Detach any media rolls from the printer. Remove the original power supply cable from the back of the printer.
2. Turn the printer over and align the power base to the bottom of the printer, with the printer power plug oriented toward the rear of the printer.

The printer's rubber feet align with recesses in the top of the power base.

3. Use the two screws provided to attach the power base to the printer. Tighten the screws using the Torx wrench supplied in the kit.



Installing the Battery into the Attached Battery Base



IMPORTANT: The printer must have an Attached Battery Base installed and securely connected your printer to prevent damage to the printer or the battery.

1. Disconnect the printer's external power supply from the DC power input socket located on the back of the printer.

- 2. Slide the battery into the battery base's battery slot. Push the battery into the base until the battery pack is flush to the rear of the battery base and the connectors on the battery pack are engaged with the ports on the back of the printer.

Figure 6 Battery Ready to Install



1	Battery latch
---	---------------



1	Battery latch
---	---------------



IMPORTANT: Batteries are shipped in Shutdown Mode for safety and to keep the battery from discharging during storage and shipping. The battery requires charging prior to initial use with the printer.

3. Attach the printer's power supply to the battery to wake up the battery from Shutdown mode and begin its initial charge.



4. Ensure the printer has a fully charge before using it for the first time.

See [Battery Indicators and Controls](#) on page 25 to learn how to turn battery power on, discover battery charge saving features and behaviors, and check the battery's charge level and health.

The printer takes approximately two hours to reach a full charge from a no-charge state. The battery status (health) indicator showing the lighting bolt changes from Amber (charging) to Green (charged).

Update Printer Firmware to Complete the Options Installation

To ensure optimal printer performance, routinely update the printer's firmware with the latest version. See [Updating Printer Firmware](#) on page 109.

The most current instructions are available on the Zebra web site at zebra.com/support.

Setup

This section assists you in setting up and operating your printer for the first time.

Setting up the Printer – Process Overview

Use this high-level outline of how to set up your Zebra printer to plan for both stages of the process: (1) setting up the hardware, and (2) setting up communications between the printer and the device or PC you will use to manage the printer.



IMPORTANT: After finding an appropriate location for the printer and BEFORE turning printer power ON, download printer drivers for your printer and Zebra Setup Utilities on the laptop or PC that you will use to set up and manage the printer. Go to the Zebra web site at zebra.com/zd410d-info to download the drivers.



NOTE: You will need a roll of media (labels, receipt paper, or tags) to set up your printer for the first test print. See the Zebra web site or contact your reseller to help you select the right media for your use. Find media at zebra.com/supplies.



IMPORTANT: Do NOT connect your printer to a computer yet! If you connected your printer to a computer via USB BEFORE you install the drivers, the printer might appear as an unknown (unspecified) device in the “Devices and Printers” list. Follow the instructions in [What To Do If You Forget to Install the Printer Drivers First](#) on page 87 before you perform step 1.

This is a simplified instruction list to assist you in planning a basic printer setup.

1. Run the downloaded Windows Printer Driver v8 file from your Windows computer.
The driver executable file (such as `zd86423827-certified.exe`) is added to your Download folder. See [Installing the Drivers](#) on page 66.
2. On your printer hardware, install any hardware options you plan to use, See [Install Hardware Options](#) on page 29.
3. Place the printer in a safe location with access to a power source, from where you can connect the printer to your PC, laptop or mobile device using physical interface cables or using a wireless connection. See location considerations in [Attaching Power](#) on page 46.
 - See [Select a Location for the Printer](#) on page 45.
 - See [Attaching Power](#) on page 46.
 - See [Interface Cable Requirements](#) on page 60 and [Interface Connector Wiring](#) on page 156.
4. Remove the outside layer of your media roll to keep grit, adhesive, and other handling contaminants from damaging the printhead.

5. Load media. Typically this is a roll of labels, receipt paper, or tags and adjust the movable sensor as necessary for the type of media you have loaded. See [Loading Roll Media](#) on page 53.
 - For label and receipt (continuous) media roll, see [Adjust the Movable Sensor for Web \(Gap\) Sensing](#) on page 56.
 - For label and receipt (continuous) media roll, see [Adjust the Movable Sensor for Black Marks or Notches](#) on page 54.
6. Turn printer power ON. See [Operator Controls](#) on page 21.



IMPORTANT: Make sure the communication interface cables are NOT connected to the computer!

7. Calibrate media properties and label positioning. See [Running a SmartCal Media Calibration](#) on page 58.
8. Print a Configuration Report as a test print. See [Printing the Printer Configuration Report \(CANCEL Self Test\)](#) on page 141.

You will need the information in the Printer Configuration report to connect the printer to a management device.
9. Turn printer power OFF. See [Operator Controls](#) on page 21.
10. Access zebra.com/setup to download and install Zebra Setup Utilities (ZSU) for your Windows OS. These utilities includes the latest printer configuration wizards and various other tools to assist you in managing your printer.



NOTE: Optionally download the Android, iPhone, or iPad apps made available by Zebra to manage your printer (see [Connect to a Phone or Tablet](#) on page 65).

11. Choose a method to interface with and manage your printer, using a wired or wireless connection between your printer and the device: USB port, serial port (option), or the optional Ethernet/LAN module. See [Interface Cable Requirements](#) on page 60, [Interface Connector Wiring](#) on page 156, and [Wi-Fi and Bluetooth Classic Wireless Connectivity Option](#) on page 72. If using a physical connection, be sure printer power is OFF when you connect the printer cable to the network or host system.
 - a) For USB printer communication ports, connect the supplied USB cable to the printer.



NOTE: You must have the Windows Printer Drivers v8 installed BEFORE you connect the USB cable to the computer and the printer and then turn printer power ON.



- b) For non-USB printer communication ports, run the Windows Printer Driver v8 previously used to preload the drivers. The driver executable file (such as `zd86423827-certified.exe`) was added to your Download folder. See [Running the Printer Installation Wizard](#) on page 69.
12. Turn printer power ON when instructed.
 - Windows should automatically detect and configure your printer for USB port operations.
 - Other connection types such as wired or wireless networks (Ethernet and Wi-Fi), Bluetooth, and serial port will require additional setup. Follow the on-screen instructions and prompts to complete the process.

After completing the basic setup, begin the software-based configuration for either wired or wireless communication methods typically needed for Windows OS. See [Setting up Windows to Printer Communication \(Overview\)](#) on page 65.

Select a Location for the Printer

The printer and media must be situated in a clean and safe area with moderate ambient temperatures to ensure optimal print operations.

Select a location for the printer that meets these conditions:

Surface	The surface where the printer will be located must be solid, level, and of sufficient size and strength to hold the weight of the printer when it has a full roll of media loaded.
Space	<p>The area where the printer will be located must include enough space to easily open the printer for media loading and routine cleaning, and for accessibility to power sources and wired connectivity as needed.</p> <p>To allow for proper ventilation and cooling, leave open space on all sides of the printer.</p> <p> IMPORTANT: Do NOT use any padding or cushioning material under or around the base of the printer. It will restrict air flow and could cause the printer to overheat.</p>
Power	Place the printer close to an easily accessible power outlet.
Data communication interfaces	<p>Make sure that printer cabling as also Wi-Fi or Bluetooth radios do not exceed the maximum distance from the printer as specified by the communication protocol standard or product data sheet for this printer.</p> <p> NOTE: Radio signal strength can be reduced by physical barriers (objects, walls, etc.).</p> <p>Data cables should not be routed with or near power cords or conduits, fluorescent lighting, transformers, microwave ovens, motors or other sources of electrical noise and interference.</p> <p> NOTE: These interference sources may cause problems with communications, host system operation, and printer functionality.</p>
Operating conditions	<p>Your printer is designed to function in a wide range of environments. The temperature and relative humidity requirements for the printer are as follows:</p> <ul style="list-style-type: none"> • Operational requirements <ul style="list-style-type: none"> • Temperature: 0°C to 40°C (32°F to 104°F) • Humidity: 20% to 85% non-condensing • Non-operational requirements (such as when not in use and in storage) <ul style="list-style-type: none"> • Temperature: -40°C to 60°C (-40°F to 140°F) • Humidity: 5% to 85% non-condensing

Install Printer Options and Connectivity Modules

If installing one or more of the following printer options, complete the installation(s) before setting up the printer.

For this option...	See these instructions...
Serial (RS-232 DB-9) port module	Installing the Serial Port Module on page 31.
Internal Ethernet (LAN) module	Installing the Internal Ethernet (LAN) Module on page 32.
Label Dispenser (peel-off liner and dispense printer media format)	Installing the Label Dispenser on page 34.
General purpose media cutter	Installing the Cutter on page 35.
Media Core Adapter kit for 38.1 mm (1.5 in.), 50.8 mm (2.0 in.), or 76.2 (3.0 in.) inner diameter (I.D.) media cores	Media Roll Core Size Adapters on page 36.
Attached battery base	Installing the Attached Battery Base Option on page 38.
Battery pack	Installing the Battery into the Attached Battery Base on page 39.

Attaching Power



CAUTION: Never operate the printer and power supply in an area where they can get wet. Serious personal injury could result!



IMPORTANT: Set up your printer so that you can handle the power cord easily if needed. Some processes for setup or troubleshooting issues may ask you to remove power. Separate the power cord from the power supply receptacle or AC electrical outlet to make certain the printer cannot carry electrical current.



IMPORTANT: Ensure the appropriate power cord with a three-prong plug and an IEC 60320-C13 connector are used at all times. These power cords must bear the relevant certification mark of the country in which the product is being used.

1. Plug the power supply into the printer's DC power receptacle.
2. Insert the AC power cord into the power supply.

3. Plug the other end of the AC power cord into an appropriate AC electrical outlet.



NOTE: The plug on the AC outlet end of the power cord may vary by region.

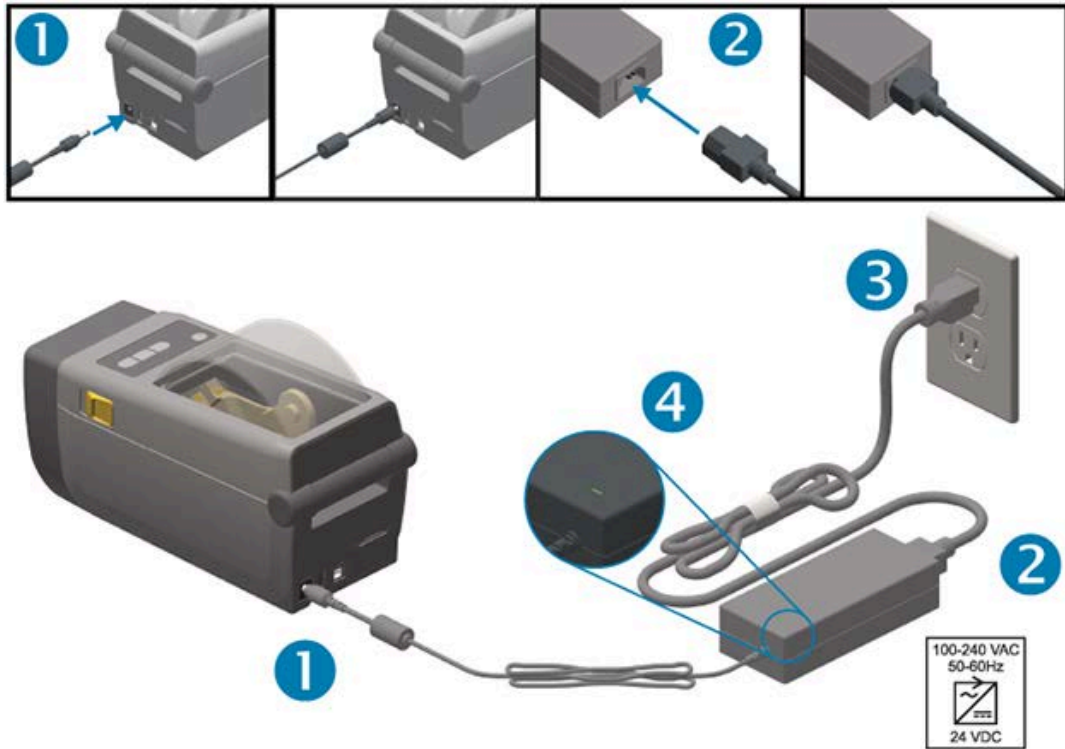

4. Verify that the active power light shows green, indicating that power is on at the AC outlet.

Get Ready to Print

You will need print media to complete the printer setup.

Your use cases will determine what type of media you need: labels, tags, tickets, receipt paper, fanfold stacks, tamper-proof labels, or other) types

If possible, use the same media for the initial printer setup that you will be using for the normal operations after the printer is set up. This will help you more easily identify any setup issues at the start.

The printer does not ship with media. The Zebra web site or your reseller may be able to help you select the right media for your intended printing application (see zebra.com/supplies).

Prepare and Handle Media

Careful handling and storage of your media is important in order to maximize print quality.

If the media becomes contaminated or dirty, it can damage the printer and cause defects in the printed image (voids, streaks, discoloration, compromise the adhesive, etc.).

During manufacturing, packaging, handling and storage, the outside length of media may become dirty or contaminated. Remove the outside layer of the media roll or stack before you load the roll into the printer media compartment. This will remove any contaminants which might be transferred onto the printhead during normal operation.

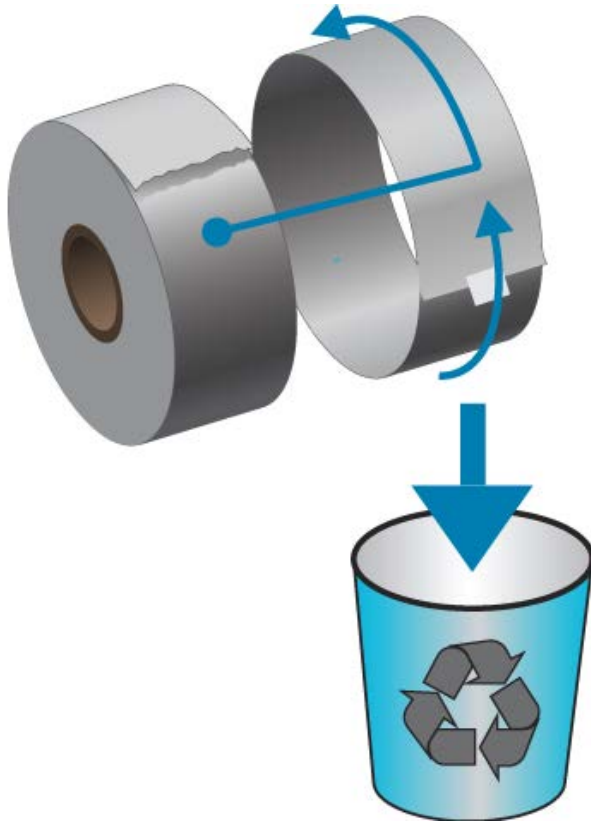

Media Storage Tips

- Store media in a clean, dry, cool, dark area.



NOTE: Direct thermal media is chemically treated to be heat sensitive to enable thermal printing. Direct sunlight or heat sources may 'expose' the media.

- Do not store media with chemicals or cleaning products.
- Leave media in its protective packaging until it is to be placed in the printer for use.
- Many media types and label adhesives have a 'shelf life' or expiration date. Always use the oldest, viable (non-expired) media first.

Roll Media Sensing and Media Loading

The printer uses two sensing methods to accommodate a wide range of media:

- Center area transmissive sensing, for continuous media and gap/web label media.
- Full-width movable (reflective) sensing, for print format (length) demarcation using black marks, black lines, notches or holes.

Media Type	Sensing Method
Web/gap media	The printer senses the differences between the label and the liner to determine the print format length.

Media Type	Sensing Method
Continuous roll media	The printer only senses the media's characteristics. The print format's length is set by programming (driver or software) or the last stored form's length.
Black mark media	The printer senses the beginning of the mark and the distance to the start of the next black mark to measure the print format length.

For other common media and setting variations, see one of the following:

- [Using the Label Dispenser Option](#) on page 100
- [Printing on Fanfold Media](#) on page 97

Set Media Sensing by Media Type

- For web/gap media, the printer senses the differences between the label and the liner to determine the print format length.
- For continuous roll media, the printer only senses the media's characteristics. The print format's length is set by programming (driver or software) or the last stored form's length.
- For black mark media, the printer senses the beginning of the mark and the distance to the start of the next black mark to measure the print format length.
- For other common media and setting variations, see one of the following:
 - After loading media, follow the steps in [Using the Label Dispenser Option](#) on page 100.
 - If using fanfold media, see [Printing on Fanfold Media](#) on page 97.

Loading Media

This procedure works for Tear-Off (standard bezel), Label Dispense, and Media Cutting printer options.

1. Open the printer. Pull the release latch levers toward the front of the printer.

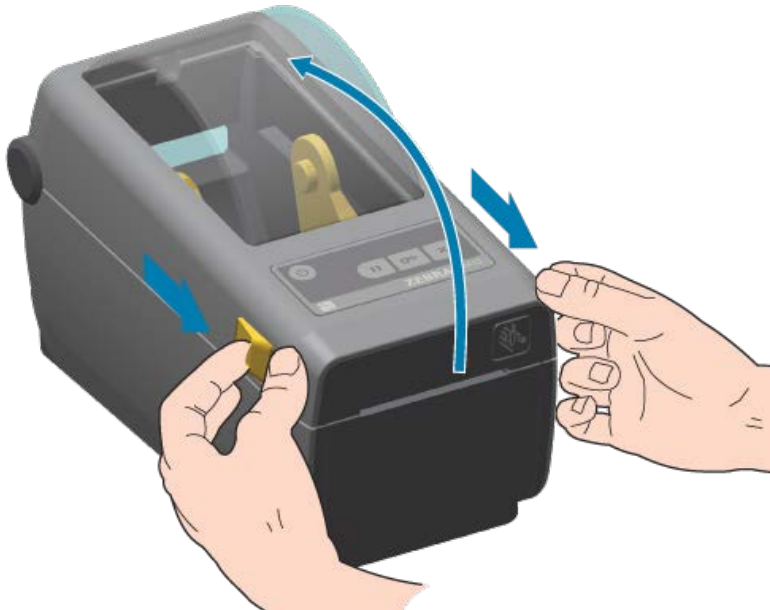

2. Open the media roll holders. Orient the media roll so that its printing surface will face up as it passes over the platen (drive) roller. Pull the media guides open with your free hand and place the media roll on the roll holders and release the guides. Verify the roll turns freely. The roll must not sit in the bottom of the media compartment.

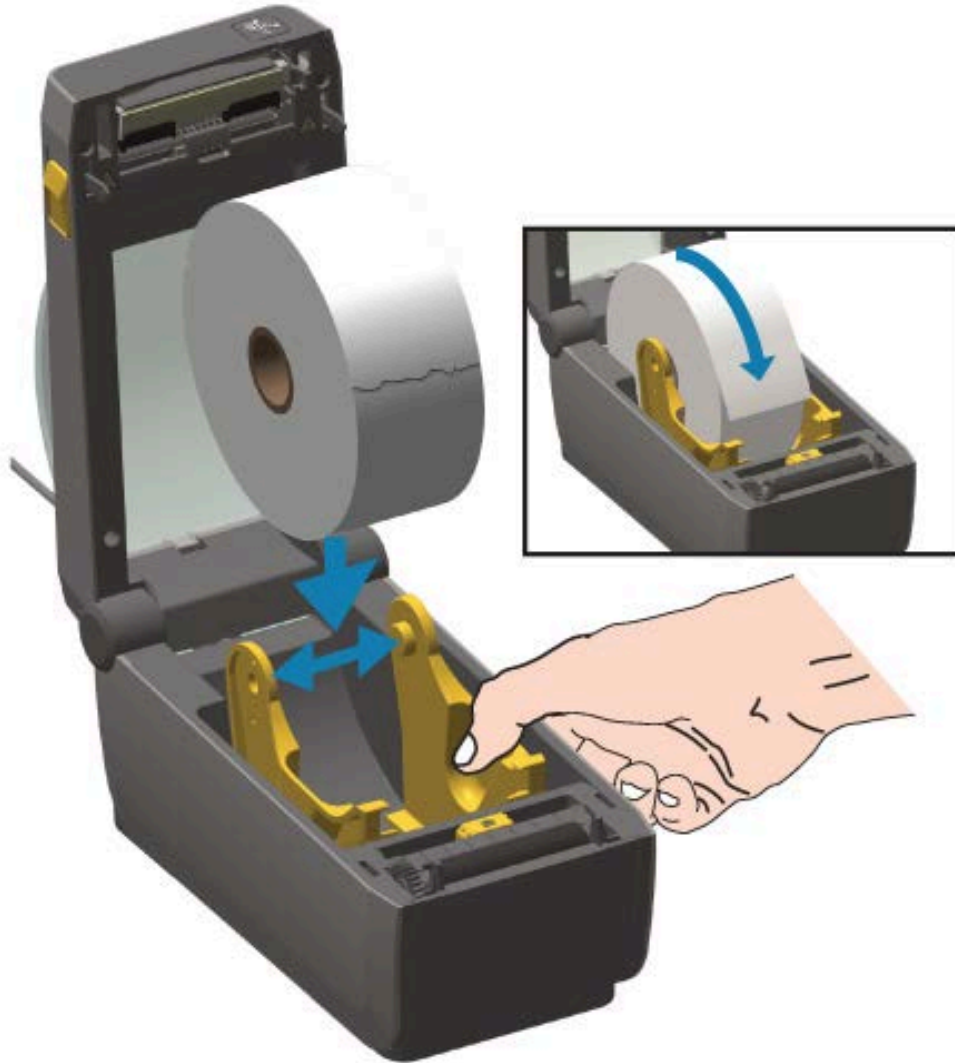

3. Pull the media so that it extends out of the front of the printer.

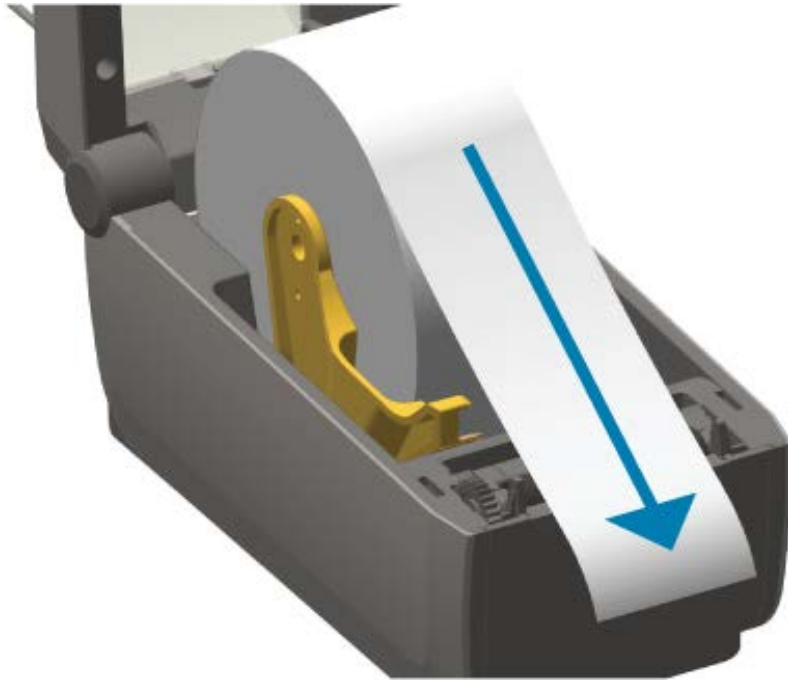

4. Push the media under both of the media guides.

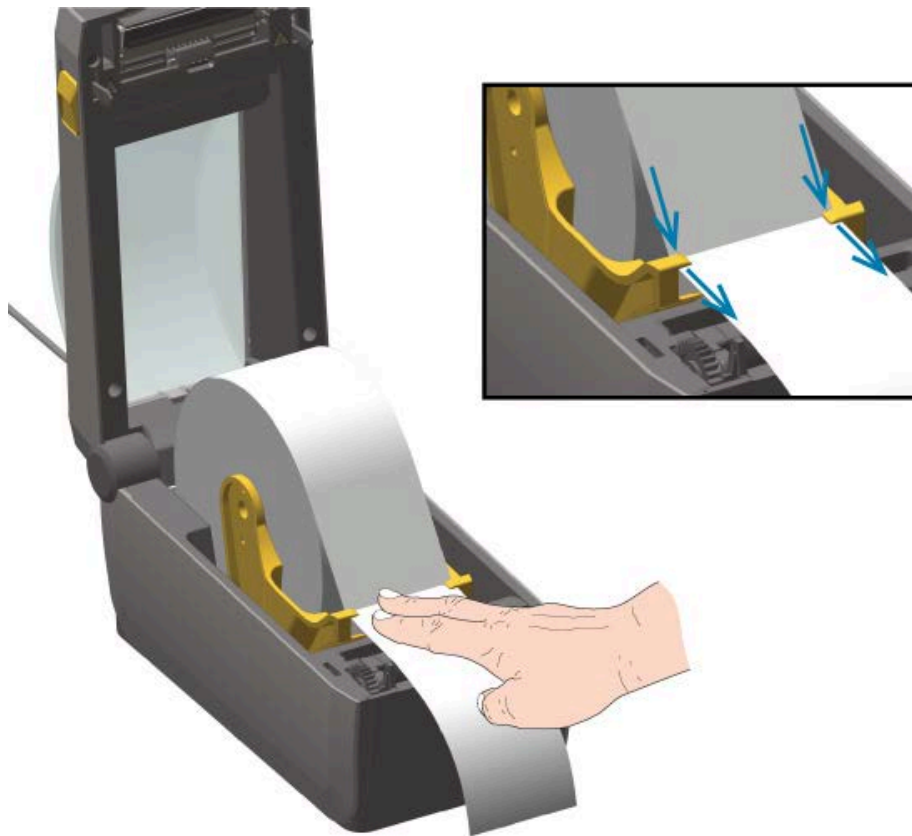

5. Flip the media up and align the movable media sensor for your media type.

- For continuous roll receipt type media or label media without black marks or notches, align the media to the default center position.
- For black mark (black line, notches or holes) backed media, adjust the sensor position so the sensor aligns to the center of the black mark. Avoid the center area of the media to only use black mark sensing for operation with black marks.

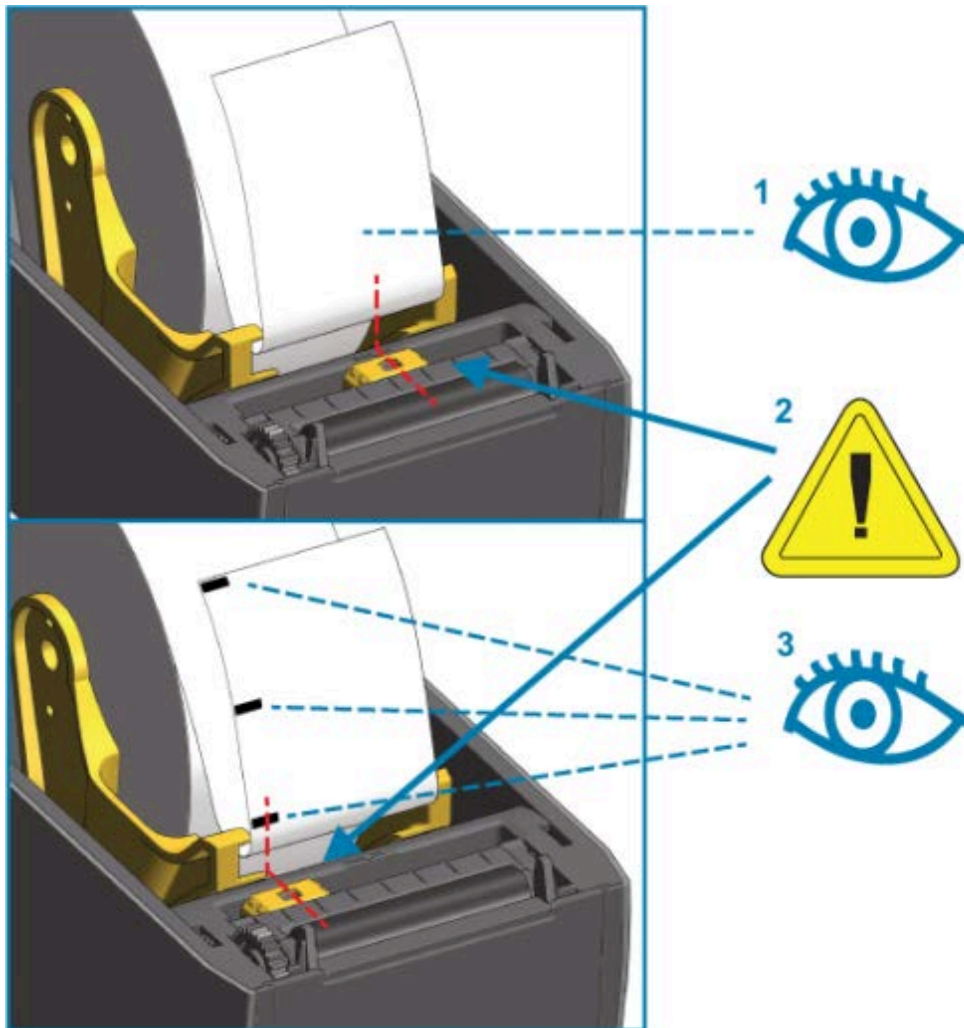

1	Web (gap) sensing standard operating position (default)
2	Movable sensor
3	Off center (for black-mark sensing only)

Loading Roll Media

Use these steps to install media in printers which have the optional cutter module installed.

1. Thread the media through cutter's media slot and pull it out the front of the printer.

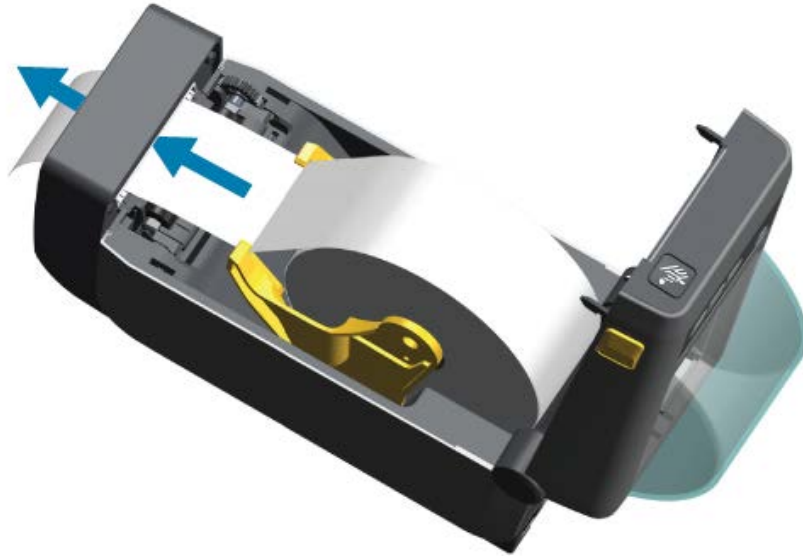

2. Press the printer cover down until it snaps closed.



NOTE: You may have to calibrate your printer for the media. To operate properly, the printer's sensors must be in the right position to sense the label, the liner, and the distance between the labels. When reloading the same media (size, vendor, and batch), simply press **FEED** () one time to prepare the media for printing.

Movable Sensor Adjustment

The movable sensor is a dual-function sensor. It provides transmissive (sees through media) and reflective media sensing. The printer can use either sensing method, but not both simultaneously.

The movable sensor has a center array of sensors. This provides adjustable transmissive web (gap) sensing to positions that match legacy Zebra desktop printer sensor locations and positions in between. This also provides for use of some non-standard media variations or irregularly-shaped media.

The movable sensor allows the printer to use media with black marks or notches (holes through the media) on the back side of the media (or media liner). The sensor aligns to the middle of black marks or notches not in the center of the media roll to avoid web/gap sensing array.

Adjust the Movable Sensor for Black Marks or Notches

The sensor light and its black-mark detector are situated next to each other under the sensor cover.

Black mark sensing looks for and detects non-reflective surfaces such as black marks, black lines, notches, or holes on the back of the media which do not reflect the sensor's near-infrared light beam to the sensor's detector.

Position the movable sensor's alignment arrow to the middle of the black mark or notch in the underside of the media.

The sensor position should be aligned as far as possible from the edge of media but where 100% of the sensor window is covered by the mark.



NOTE: When printing, the media can move from side to side ± 1 mm (due to media variations and edge damage due to handling). Notches cut into the side of the media can also become damaged.

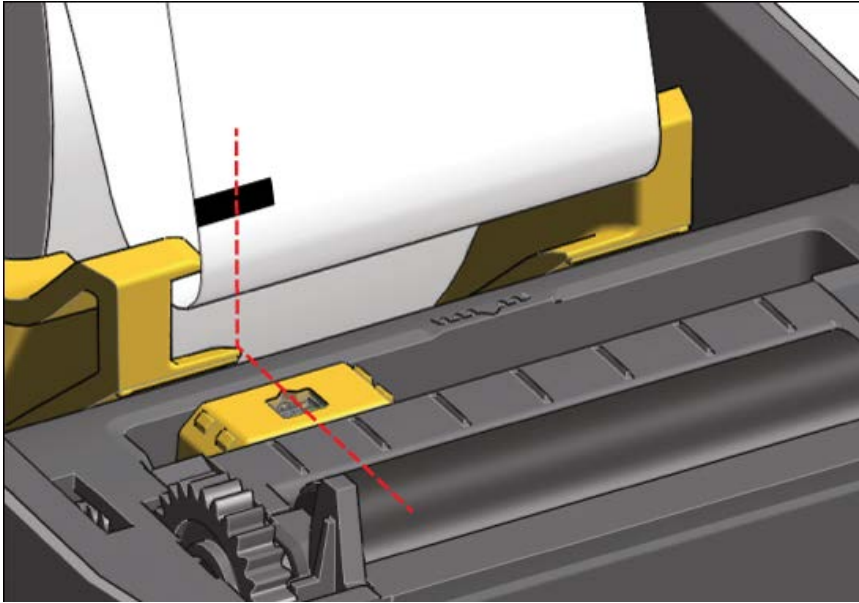

Adjust the Movable Sensor for Web (Gap) Sensing

The movable sensor for web/gap sensing supports multiple positions.

- The movable sensor's default position is ideal for most label types.

Figure 7 Default Gap Sensing Position

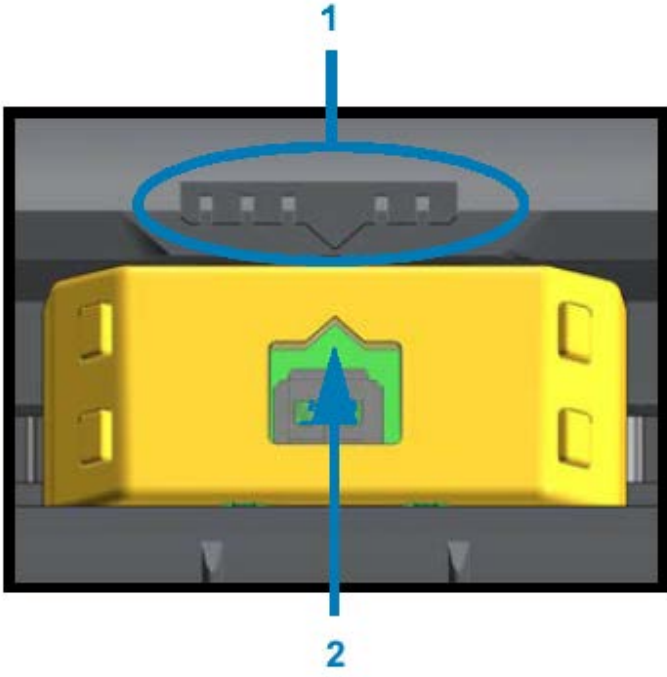

1	Sensor alignment key
2	Alignment arrow (default position)

- The adjustment range is from center to off-center positions which are ideal for printing two labels side by side on a roll.

Figure 8 Center Line on the Media

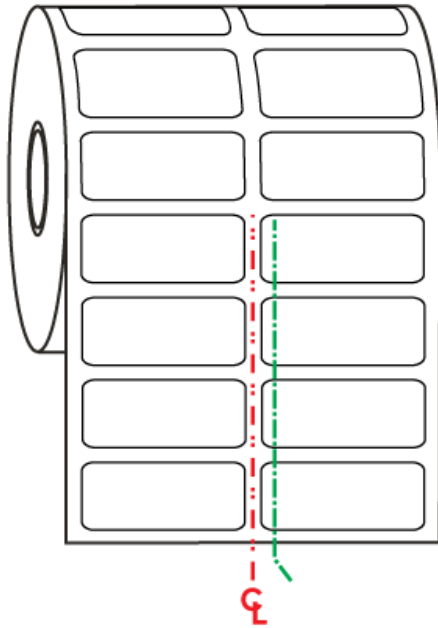

- The movable sensor adjustment range covers sensor positions used by legacy Zebra printers.

Web (gap) sensing with the printer's movable sensor functions only when the movable sensor's alignment arrow points to any position on the alignment key. The adjustment range is shown below in three positions: center-aligned, default, and maximum right.

Figure 9 Adjustment Range from Left to Right

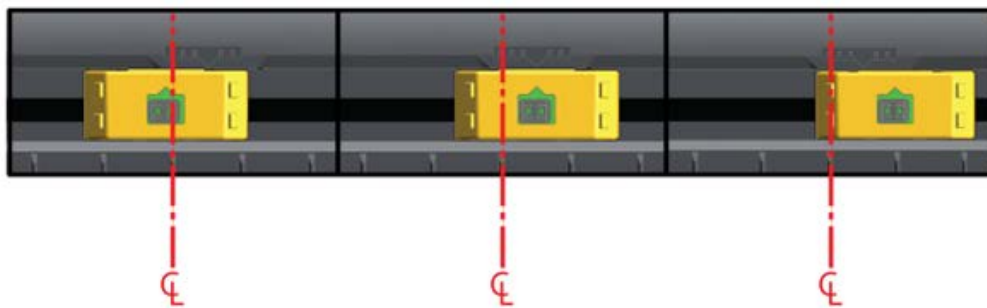

Relative to the fixed sensor position of the ZD410 printer:

- The position for these Zebra models are at default.
 - LP/TLP 2824 Plus
 - G-Series fixed position sensors LP/TLP 2842, LP/TLP 2844, and LP/TLP 2042





- The position for the following Zebra model is center-aligned:
 - LP/TLP 2742

Running a SmartCal Media Calibration

When you load media, the printer needs information about the media before it can print for optimal operation. Your printer automatically determines the type of media (web/gap, black mark/notch, or continuous) and measures media characteristics. However, if the media type you are loading is different from the previous media you loaded in terms of type, size, or batch, you must calibrate the new media using this procedure.



IMPORTANT: After you complete initial calibration to a specific media, you do NOT have to perform additional calibrations each time the media is replaced, provided the media is the same type and batch. The printer automatically measures the media to adjust for small changes in the media characteristics while printing.

1. Make sure the media is loaded properly and the top cover of the printer is closed.
2. Press **POWER** () to apply power to the printer.
3. After the printer is in the ready state, meaning the Status indicator () is lit solid Green), press and hold **PAUSE** () and **CANCEL** () simultaneously for two seconds and release.





At the end of the SmartCal operation, the printer measures a few labels and adjusts media sensing levels. When the printer stops, the Status indicator () turns solid Green.



IMPORTANT: To synchronize the labels after you load a new roll of media (same size, type, and batch) and continue printing, press **FEED** () once or twice.

Testing Printing with the Configuration Report

Before you connect the printer to a computer, ensure that the printer is in working order. You can do this by printing a Printer Configuration report and a Network Configuration report. The information on these reports may come in handy during printer installation, configuration, and troubleshooting .

1. Make sure the media is properly inserted and the top cover of the printer is closed.
2. Turn printer power ON.
3. Once the printer is in the ready state, meaning the Status indicator () lights solid Green, press and hold **FEED** () and **CANCEL** () simultaneously for two seconds and release.

The printer outputs the Printer Configuration Report and the Network Configuration Report in sequence.

4. When the printer stops, the Status indicator () turns solid Green.

```

PRINTER CONFIGURATION
Zebra Technologies
ZTC ZD410-300dpi ZPL
80J1B32C0130

+20.0..... DARKNESS
LOW..... DARKNESS SWITCH
4.0 IPS..... PRINT SPEED
+000..... TEAR OFF
TEAR OFF..... PRINT MODE
MARK..... MEDIA TYPE
REFLECTIVE..... SENSOR SELECT
840..... PRINT WIDTH
1104..... LABEL LENGTH
38.0IN 889MM..... MAXIMUM LENGTH
MAINT OFF..... EARLY WARNING
NOT CONNECTED..... USB COMM.
AUTO..... SER COMM. MODE
8800..... BAUD
8 BITS..... DATA BITS
NONE..... PARITY
XON/XOFF..... HOST HANDSHAKE
NONE..... PROTOCOL
NORMAL MODE..... COMMUNICATIONS
<^> ZCH..... CONTROL PREFIX
<^> SEH..... FORMAT PREFIX
<.> ZCH..... DELIMITER CHAR
ZPL II..... ZPL MODE
INACTIVE..... COMMAND OVERRIDE
NO MOTION..... MEDIA POWER UP
FEED..... HEAD CLOSE
DEFAULT..... BACKFEED
+000..... LABEL TOP
+0000..... LEFT POSITION
DISABLED..... REPRINT MODE
042..... WES SENSOR
088..... MEDIA SENSOR
128..... TAKE LABEL
070..... MARK SENSOR
004..... MARK RED SENSOR
000..... TRANS GAIN
100..... TRANS LED
088..... MARK GAIN
058..... MARK LED
DPCSNFWM..... MODES ENABLED
840 12/PM FULL..... MODES DISABLED
3.0..... RESOLUTION
3.0..... LINK-OS VERSION
V77.18.14Z <- FIRMWARE
1.3..... XPL SCHEMA
6.5.0 0.515..... HARDWARE ID
8138K..... RAM
65536K..... E: ONBOARD FLASH
NONE..... FORMAT CONVERT
ENABLED..... IDLE DISPLAY
01/01/70..... RTC DATE
01:11..... RTC TIME
DISABLED..... ZBI
2.1..... ZBI VERSION
READY..... ZBI STATUS
312 LABELS..... NONRESET CNTR
312 LABELS..... RESET CNTR1
312 LABELS..... RESET CNTR2
1.593 IN..... NONRESET CNTR
1.593 IN..... RESET CNTR1
1.593 IN..... RESET CNTR2
4.047 CM..... NONRESET CNTR
4.047 CM..... RESET CNTR1
4.047 CM..... RESET CNTR2
EMPTY..... SLOT 1
0..... MASS STORAGE COUNT
0..... HID COUNT
OFF..... USB HOST LOCK OUT
FIRMWARE IN THIS PRINTER IS COPYRIGHTED
    
```

```

Network Configuration
Zebra Technologies
ZTC ZD410-300dpi ZPL
XXXXXX-XX-XXXX

Bluetooth
1.4.0.0..... FIRMWARE
02/02/2015..... DATE
on..... DISCOVERABLE
4.0..... RADIO VERSION
on..... ENABLED
20:C3:8F:D6:9E:99..... MAC ADDRESS
XXXXXX-XX-XXXX..... FRIENDLY NAME
no..... CONNECTED
..... MIN SECURITY MODE
..... CONN SECURITY MODE
not supported..... iOS
FIRMWARE IN THIS PRINTER IS COPYRIGHTED
    
```

If you cannot get these reports to print, see [Troubleshooting](#) on page 133.

Interface Cable Requirements

Data cables must be of fully-shielded construction and fitted with metal or metalized connector shells. Shielded cables and connectors are required to prevent radiation and reception of electrical noise.

To minimize electrical noise pickup in the cable:

- Keep data cables as short as possible (1.83 m [6 feet] recommended).
- Avoid tightly bundling the data cables with power cords.
- Be sure NOT to tie the data cables to power wire conduits.



CAUTION: This printer complies with FCC Rules and Regulations, Part 15, for Class B Equipment, using fully-shielded data cables. Use of unshielded cables may increase radiated emissions above Class B limits.

USB Interface

Universal Serial Bus (version 2.0 compliant) provides a fast interface that is compatible with your existing PC hardware. USB's "plug and play" design makes installation easy. Multiple printers can share a single USB port/hub.

When using a USB cable (not supplied with your printer), verify that the cable or cable packaging bears the Certified USB mark to guarantee USB 2.0 compliance.



Serial Interface

The printer uses a Null Modem (cross-over) cable for DTE communications. The required cable must have a nine-pin D type (DB-9P) male connector on one end which plugs into the mating (DB-9S) serial port located on the back of the printer. The other end of this signal interface cable connects to a serial port on the host computer.

For pin-out information, see [Serial Port Interface](#) on page 157.

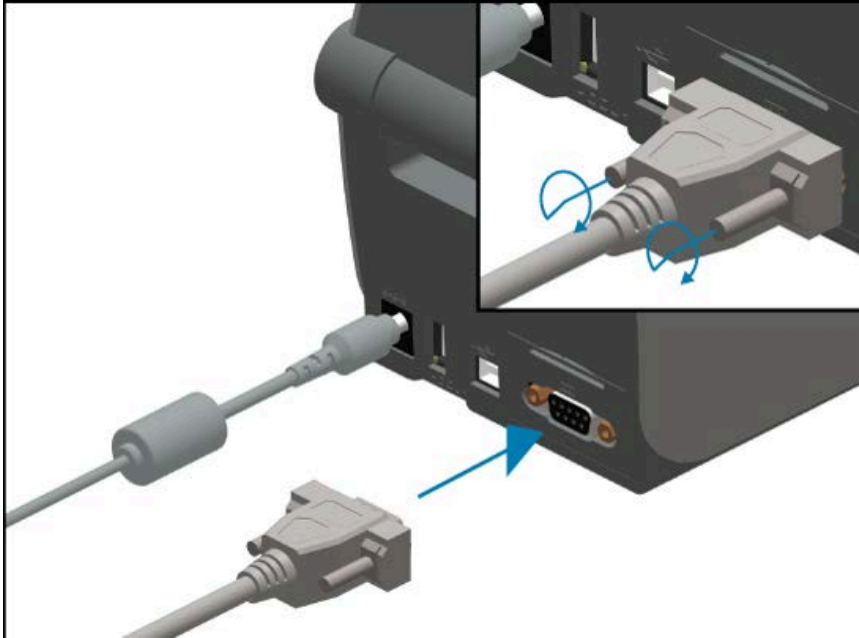

The serial port communication settings between the printer and host (typically a PC) must match for reliable communication. The settings that need changing most often are Bits per Second (bps, also known as baud rate) and Flow Control.

To set serial communications between the printer and the host computer, you can use the `^SC ZPL` programming command. Alternatively, reset the printer to its default printer configuration.

Factory defaults for serial communication settings are:

- Bits per Second (baud rate): 9600
- Word length: 8-bit
- Parity: NO
- Stop bit: 1
- Software data flow control (in the Windows-based host system): XON/XOFF



IMPORTANT: Do not use RS-232 cable adapter dongles (DTE <> DCE) with this printer. Some dongles can interfere with the operation of USB host port devices at printer power-up.

Ethernet (LAN, RJ-45)

The printer requires UTP RJ45 Ethernet cable rated CAT-5 or better.

The printer has a built-in network print server. For more information on configuring your printer to run on a compatible Ethernet based network, see the *Wired and Wireless Print Server users guide*. The printer must be configured to run on your network. The print server on board your printer can be accessed through the printer's print server Web pages.

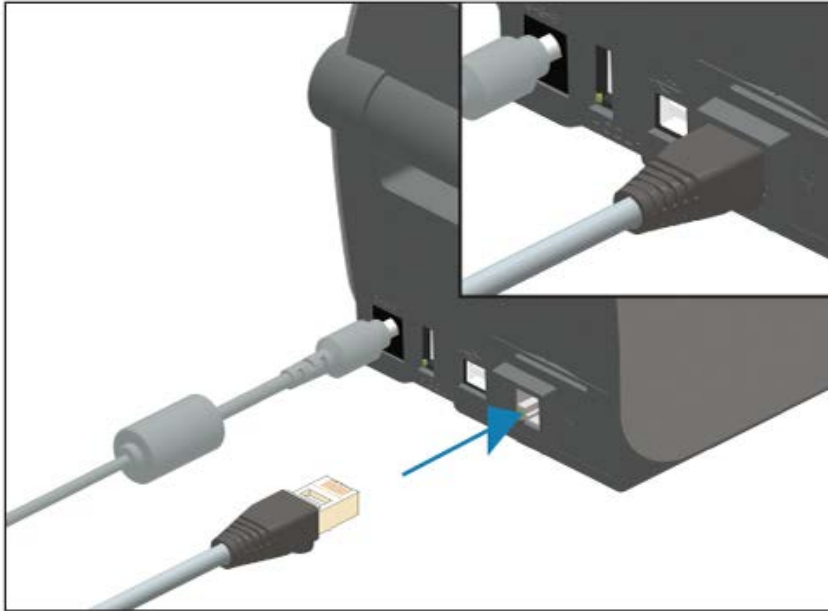

Ethernet Status/Activity Indicators

The Ethernet connector on the printer has two status/activity indicators. They are partially visible to display the status of the Ethernet interface connection at the connector. The printer also has the control panel indicator lights to display the printer's network operational status (see [Resolve Alerts and Errors](#) on page 133 for details).

LED Status	Description
Both OFF	No Ethernet link detected.
Green	100 Mbps link detected.
Green with the Amber flashing	100 Mbps link and Ethernet activity detected.
Amber	10 Mbps link detected.
Amber with the Green flashing	10 Mbps link and Ethernet activity detected.

Assign an IP Address for Network Access

All devices on an Ethernet network (LAN and WLAN) require a network IP address. You will need the printer's IP address to access the printer for configuration and printing purposes. You or a network administrator can assign an IP address to the printer using one of these methods:

- DHCP (Dynamic Host Connection Protocol) (default setting)
- Zebra Setup Utilities (includes the ZebraDesigner Windows printer driver)
- Telnet
- Mobile apps
- ZebraNet Bridge

DHCP for Personal Networks

By default, your printer is set to operate on an Ethernet LAN or Wi-Fi network with DHCP. This setting is intended primarily for personal networks. The network automatically provides a new network IP address each time the printer is powered ON.

The Windows printer driver uses a static IP address to connect to the printer. If the printer's assigned IP address has changed following the initial installation, you or a network administrator must change the IP address set in the printer driver to enable access to the printer for configuration and printing purposes.

Managed Networks

If the printer will be used in a structured network (LAN or Wi-Fi), a network administrator must assign the printer a static IP address and possibly other settings which it will need to operate on the network.

Print Server – Default User ID and Password

You may require the default User ID and/or default password to access the printer's print server or features associated with the Wi-Fi option in the printer. The factory default values are:

- User ID: admin
- Password: 1234

Setup for Windows PC or Other Device Communications

After setting up the printer hardware and printing a configuration report, you are ready to connect your printer to a device. This device can be a mobile device running the Android or Apple iOS operating systems or it can be a Windows PC.

You will use this device to run the installation utility, install printer drivers, and then configure and routinely manage your printer.

Connecting Your Printer to a Device

Zebra printers support a variety of interface options and configurations.

Printer-device interface options include:

- Universal Serial Bus (USB) interface (standard)
- RS-232 Serial interface—Field upgrade option for ZD420 printers
- Ethernet/LAN interface—Field upgrade option for ZD420 printers
- Internal Wi-Fi (802.11ac) and Bluetooth Classic 4.1 (3.0 compatible) interface—Factory-installed option; Wi-Fi models include Bluetooth Low Energy (LE, low speed connection) for printer configuration using software running on an Android or iOS devices.

Zebra Setup Utilities are designed to assist you with installing and configuring these interfaces.



NOTE: Review the cabling and unique parameters for each physical printer communication interface in [Interface Cable Requirements](#) on page 60 and [Interface Connector Wiring](#) on page 156. This will help you make configuration setup choices both before and immediately after applying power to the printer.



IMPORTANT:

Before you connect or disconnect any printer interface communications cables, make sure you have connected one end of the power cord to the printer and the other end to the power supply, See [Attaching Power](#) on page 46.

Keep printer power switched OFF when attaching the interface cable. Zebra Setup Utility configuration wizards will instruct you to turn printer power ON at the appropriate time during the driver installation.

Connect to a Phone or Tablet

Your printer can be connected to a mobile device such as a phone or a tablet running Android or Apple iOS for ease of configuring and managing the printer.

Download the free Zebra Printer Setup Utility app for your device:

- [Setup utility for Android devices](#)
- [Setup utility for Apple devices](#)

The applications support the following types of connectivity:

- Bluetooth Classic
- Wired/Ethernet
- Wireless
- USB 2.0

For the User Guides for these printer setup utilities, go to zebra.com/setup.

Setting up Windows to Printer Communication (Overview)

For supported Windows Operating systems (most common) with a Local (wired) connection:

1. Download Zebra Setup Utilities from the Zebra website at zebra.com/zd410d-info.
2. Run the Zebra Setup Utilities from your Download directory.
3. Click **Install New Printer** and run the install wizard.
4. Follow the on-screen instructions to install the printer drivers through the interface you will use to communicate with the printer. See [Installing the Drivers](#) on page 66.
5. Turn printer power ON when instructed to do so and configure printer communications for your selected interface type.
6. Use the Windows driver to print a **Test Print** to verify computer-to-printer communications. See [Printing the Printer Configuration Report \(CANCEL Self Test\)](#) on page 141.



NOTE: Wait to turn printer power ON until the second phase of the printer setup. During printer driver installation, Zebra Setup Utilities will prompt you to switch printer power ON at the appropriate stage of the process. If you switched printer power on and connected your laptop or another device to the printer BEFORE installing the drivers, see [What To Do If You Forget to Install the Printer Drivers First](#) on page 87.

Installing Drivers and Connecting to a Windows-Based Computer

To use your printer with a Microsoft Windows-based computer, you must install the correct drivers first.



NOTE: You may connect your printer to your computer using any of the supported connections that are available to you to use. However, do NOT connect any cables from your computer to the printer UNTIL you are instructed to do so by the installation wizards.

If you connect the cables at the wrong time, your printer will not install the correct printer drivers. To recover from incorrect driver installation, see [What To Do If You Forget to Install the Printer Drivers First](#) on page 87.

Pre-install Windows Printer Drivers

Zebra is changing the way you install and use your printer with your Windows-based PCs.

After you have set up the printer and verified that it can print a configuration label, you are ready to connect the printer to your device (such as a computer, phone, or tablet) and install the drivers.

We recommend that, at minimum, you pre-install the ZebraDesigner Windows driver to avail of the ease-of-use and simplicity advancements in Windows OS versions that were released after Windows XP OS version SP2.

Zebra provides the following:

- Zebra Setup Utilities (ZSU)—A suite of printer drivers, utilities, and communications and installation tools deployable on most Windows PC operating systems. They are designed to assist you with installing your printer drivers and configuring your printer.



IMPORTANT: Wait to apply power to the printer until after you have installed the drivers on the PC following the instructions in [Installing the Drivers](#) on page 66.

- ZebraDesigner printer driver—Supports 32-bit and 64-bit Windows OS and is Microsoft Certified.

Zebra Setup Utilities and Zebra Windows printer drivers are available on the CD provided with your printer. For later versions, go to the Zebra website at zebra.com. The driver and utilities support the following printer communication interfaces:

- USB port
- Parallel port
- Serial port
- Wired and wireless Ethernet
- Bluetooth (using a virtual Bluetooth printer port)

Familiarize yourself with the cabling and unique parameters for each physical printer communication interfaces. This knowledge will help you make the appropriate printer configuration choices during the setup process,



NOTE: For more information on configuring network (Ethernet or Wi-Fi) and Bluetooth communication, see the Wired and Wireless Print Server User Guide and the Bluetooth User Guide available from zebra.com/support.

Installing the Drivers

Pre-installing the printer driver is an important first step in setting up your printer.

1. Navigate to the Zebra website at zebra.com/zd410d-info.
2. On your printer's product page, click **Drivers**.
3. Download the appropriate driver for Windows.

The driver executable file (such as `zd86423827-certified.exe`) is added to your Download folder.

4. Run the executable file and follow the prompts.

When setup is complete, you may select to add the drivers to your system (Configure System) or to add specific printers, see [Running the Printer Installation Wizard](#) on page 69.

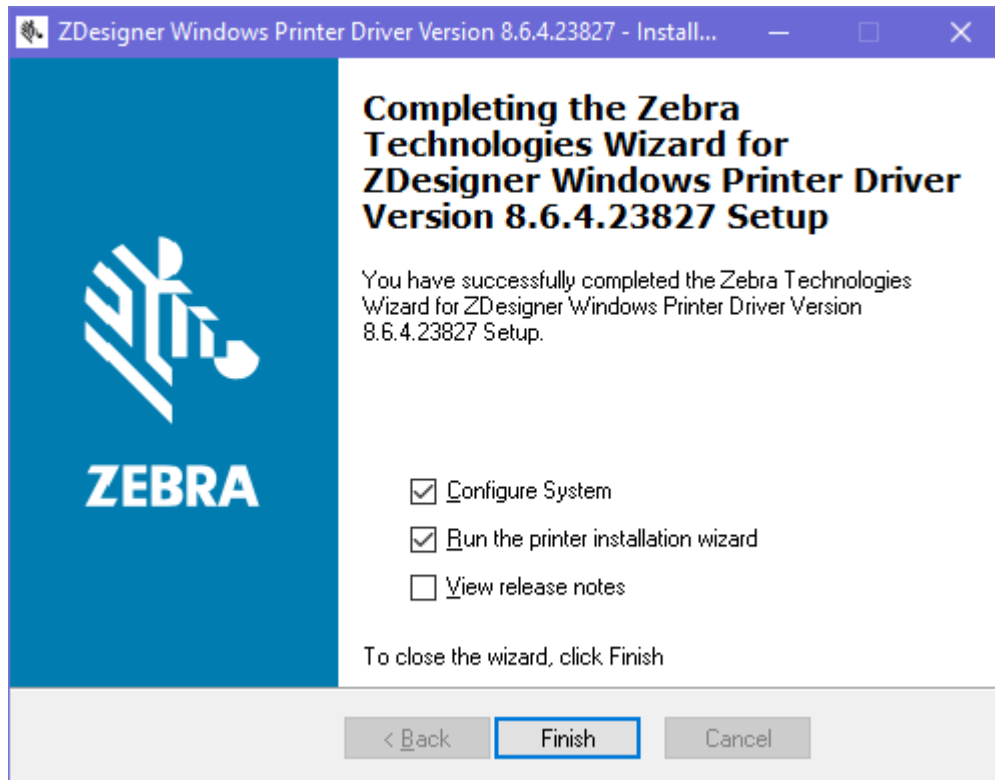

5. Select **Configure System**, then click **Finish**.

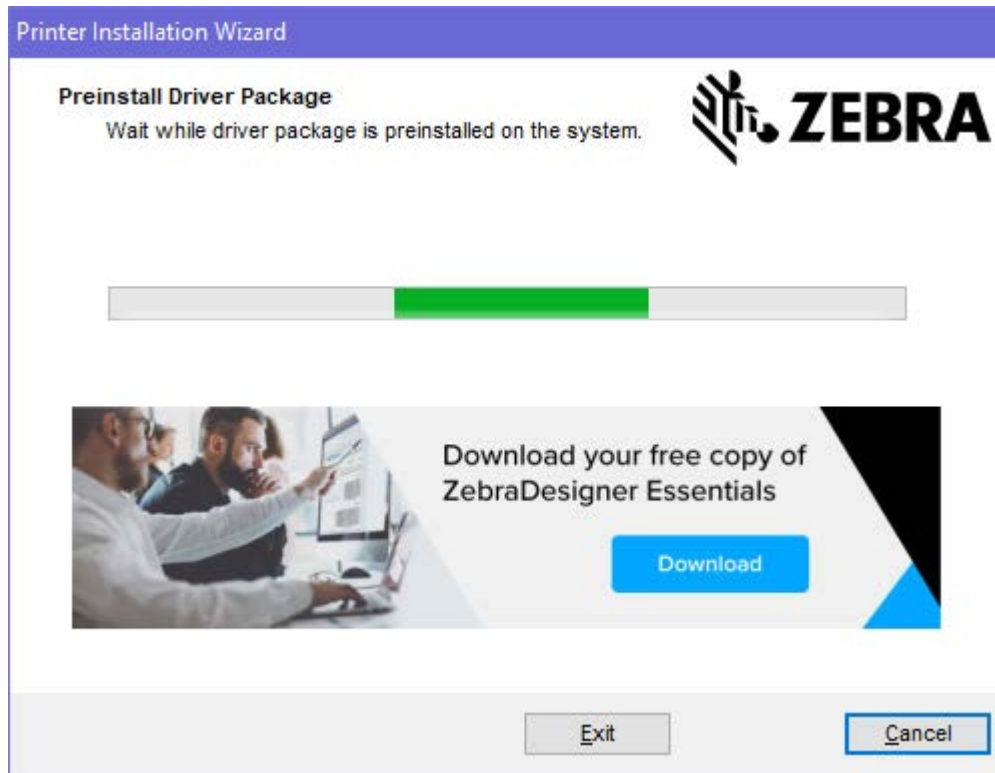

The **Printer Installation Wizard** installs the drivers.

Running the Printer Installation Wizard

1. On the last screen of the driver installer, leave Run the Printer Installation Wizard checked, and then click **Finish**.

The printer driver wizard displays.

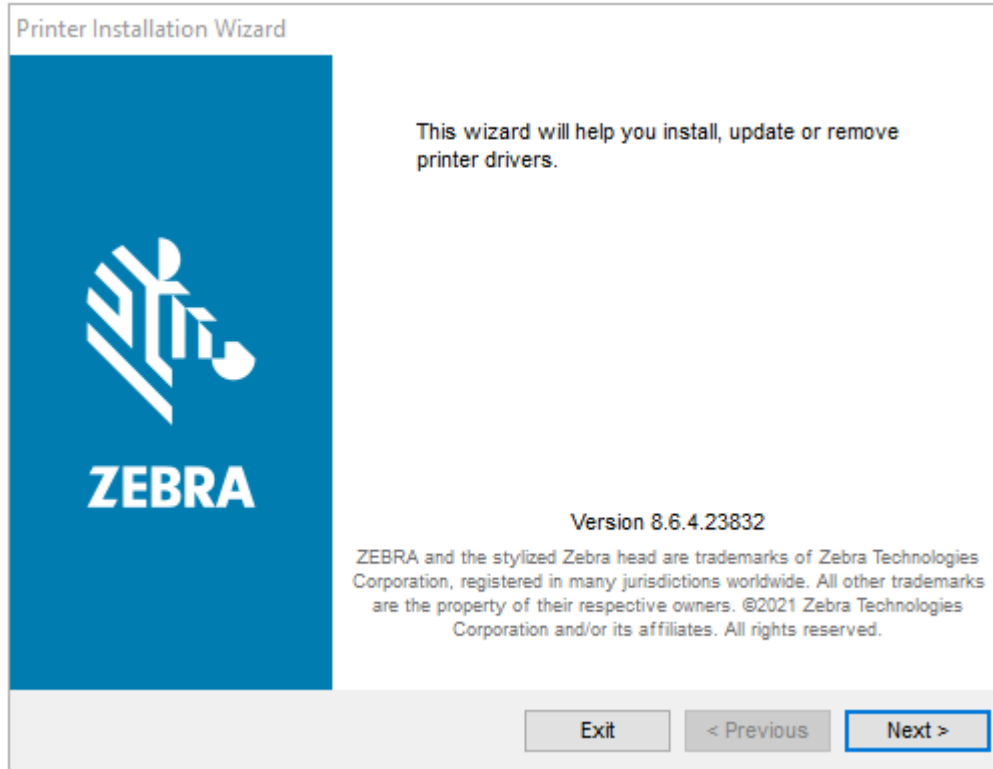

2. Click **Next**.

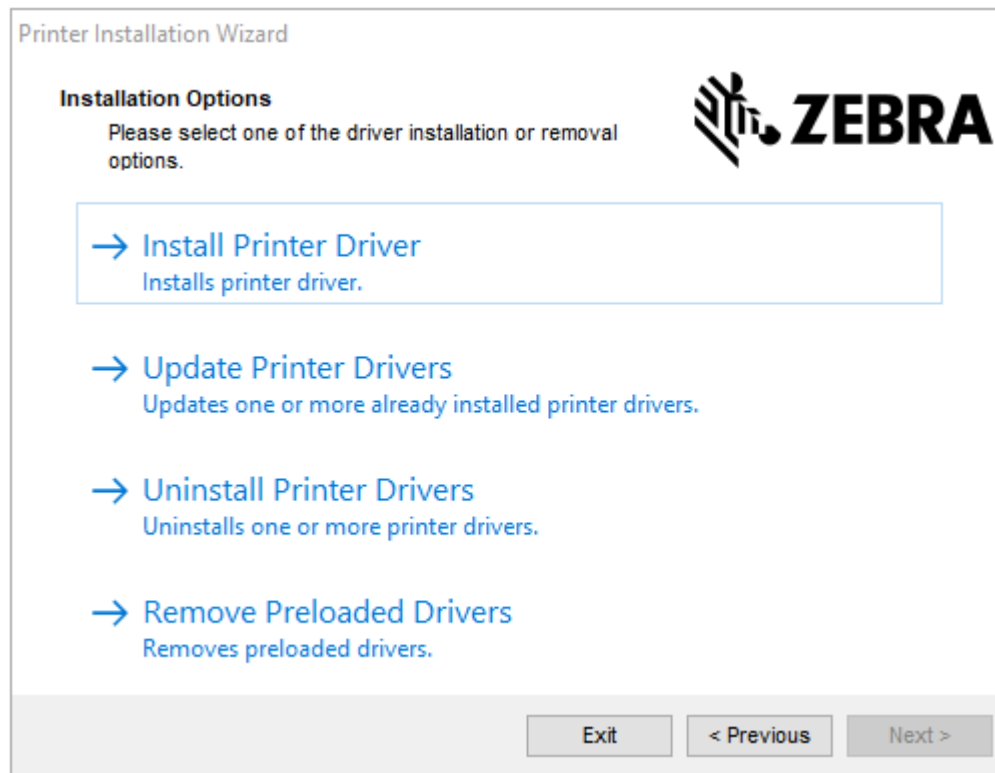

3. Click **Install Printer Driver**.

The license agreement displays.



The screenshot shows a window titled "Printer Installation Wizard" with a "License Agreement" section. The Zebra logo is in the top right. The main text reads: "END USER LICENSE AGREEMENT (UNRESTRICTED SOFTWARE)". Below this is a scrollable text area containing the following text: "IMPORTANT PLEASE READ CAREFULLY: This End User License Agreement ('EULA') is a legal agreement between you (either an individual or a company) ('Licensee') and Zebra Technologies Corporation ('Zebra') for Software, owned by Zebra and its affiliated companies and its third-party suppliers and licensors, that accompanies this EULA. For purposes of this EULA, 'Software' shall mean machine-readable instructions used by a processor to perform specific operations. BY USING THE SOFTWARE, LICENSEE ACKNOWLEDGES ACCEPTANCE OF THE TERMS OF THIS EULA. IF LICENSEE DOES NOT ACCEPT THESE TERMS, LICENSEE MAY NOT USE THE SOFTWARE." At the bottom, there are two radio buttons: "I accept the terms in the license agreement" (unselected) and "I do not accept the terms in the license agreement" (selected). Navigation buttons "Exit", "< Previous", and "Next >" are at the bottom right.

Printer Installation Wizard

License Agreement
Please read license agreement before installing printer driver.

ZEBRA

**END USER LICENSE AGREEMENT
(UNRESTRICTED SOFTWARE)**

IMPORTANT PLEASE READ CAREFULLY: This End User License Agreement ("EULA") is a legal agreement between you (either an individual or a company) ("Licensee") and Zebra Technologies Corporation ("Zebra") for Software, owned by Zebra and its affiliated companies and its third-party suppliers and licensors, that accompanies this EULA. For purposes of this EULA, "Software" shall mean machine-readable instructions used by a processor to perform specific operations. BY USING THE SOFTWARE, LICENSEE ACKNOWLEDGES ACCEPTANCE OF THE TERMS OF THIS EULA. IF LICENSEE DOES NOT ACCEPT THESE TERMS, LICENSEE MAY NOT USE THE SOFTWARE.

I accept the terms in the license agreement
 I do not accept the terms in the license agreement

Exit < Previous Next >

4. Read and accept the terms of the license agreement, then click **Next**.

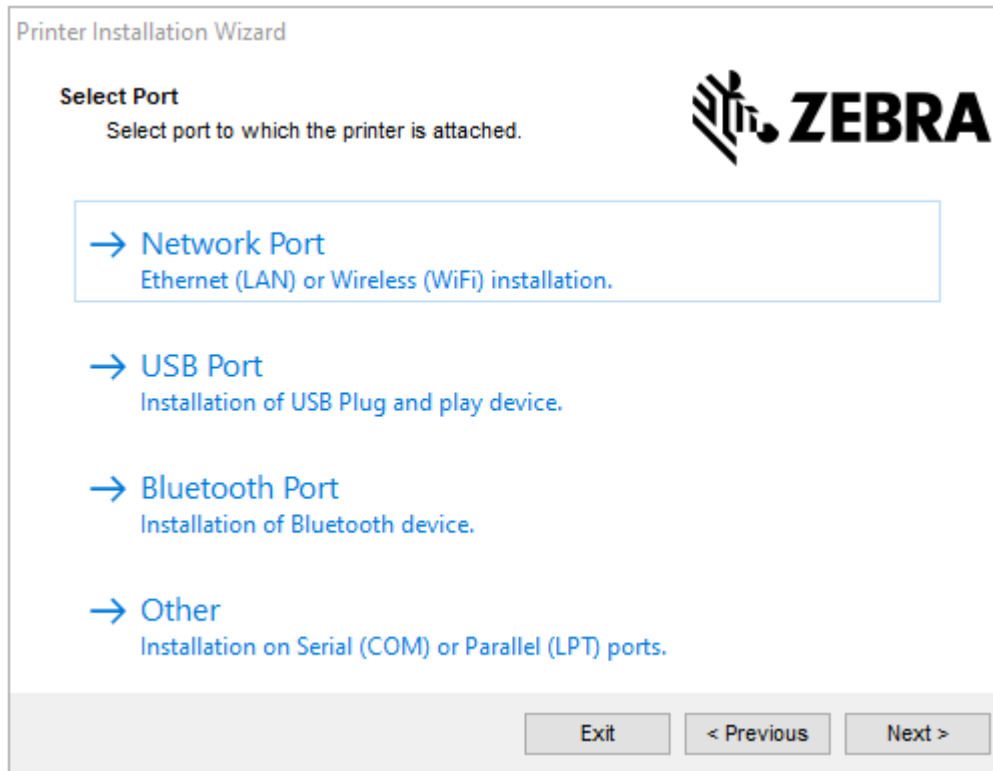

5. Select the communication option that you want to configure for your printer:
 - **Network Port**—For installing printers with an Ethernet (LAN) or wireless (Wi-Fi) network connection. Wait for the driver to scan your local network for devices and follow the prompts.
 - **USB Port**—For installing printers connected with the USB cable. Connect the printer to the computer. If the printer is already connected and powered on, you may need to remove the USB cable and install it again. The driver automatically searches for the model of the connected printer.
 - **Bluetooth Port**—For installing printers with a Bluetooth connection.
 - **Other**—For installation on another type of cable, such as Parallel (LPT) and Serial (COM). No additional configuration is necessary.
6. If prompted, select your printer model and resolution.

The model and resolution are on the printer configuration label. See [Printing the Printer Configuration Report \(CANCEL Self Test\)](#) on page 141 for instructions on printing the label.

Wi-Fi and Bluetooth Classic Wireless Connectivity Option

This guide covers basic configuration of your Internal Wi-Fi Print Server and Bluetooth Classic 4.X wireless connectivity option. This manual only covers installing the Wi-Fi as part of the Wi-Fi and Bluetooth Classic wireless connectivity option in the [Set Up the Wi-Fi Print Server Option](#) on page 73. See the Zebra Web site for Wired and Wireless Print Server User Guide for more information on the printer's Ethernet operation.

This manual only covers installing the Bluetooth as part of the Wi-Fi and Bluetooth Classic wireless connectivity option in the [Configuring Your Printer using the Bluetooth Option](#) on page 80. See the Zebra Web site for Bluetooth Wireless Guide for more information on the printer's Bluetooth operation.

Update Printer Firmware to Complete the Options Installation

To ensure optimal printer performance, routinely update the printer's firmware with the latest version. See [Updating Printer Firmware](#) on page 109.

The most current instructions are available on the Zebra web site at zebra.com/support.

Set Up the Wi-Fi Print Server Option

This section covers basic configuration of your internal Wi-Fi Print Server option. For more detailed information, refer to the Wired and Wireless Print Servers User Guide.



NOTE: The wireless radio option, which includes Wi-Fi, Bluetooth classic and Bluetooth Low Energy (LE), is available only as a factory-installed configuration.

The setup procedures in this guide explain how to configure Wi-Fi connectivity to your printer using the Connectivity Wizard, the first option listed below. Two other options are also listed.

Through the Connectivity Wizard	<p>The wizard writes a ZPL script for you based on the settings you set. You can opt to send the script command directly to your printer or save the ZPL script to a file. If you save the script to a file, you can:</p> <ul style="list-style-type: none"> • Send the file to the printer through any available connection (serial, parallel, USB, or wired print server). • Send the file to the printer again after network settings are restored to their factory defaults. • Send the file to multiple printers that need identical network settings.
Using a ZPL script that you write yourself	<p>Use the <code>^wx</code> command to set the basic parameters for security type. You can send the command through any available connection (serial, parallel, USB, or wired print server). Refer to the ZPL Programming Guide for more information on this option.</p>
Through Set/Get/Do (SGD) commands that you send to the printer	<p>Begin by using the <code>wlan.security</code> command to set the wireless security type.</p> <p>Depending on the security type you select, additional SGD commands will be necessary to specify other parameters.</p> <p>You can send the commands through any available connection (serial, parallel, USB, or wired print server). Refer to the ZPL Programming Guide for details.</p>

ZebraNet Bridge's Connectivity Wizard

The Connectivity Wizard, which is part of this software, allows you to configure your printer easily for wireless operation by writing the appropriate ZPL script for you. Use this utility when you are first installing the wireless print server or after you set the network options back to factory defaults.



NOTE: The preferred tool for connecting and configuring Link-OS printers to cloud, WLAN, and LAN is Link-OS Profile Manager. You can procure the Profile Manager and ZebraNet Bridge Enterprise (local and LAN configurations) utility from zebra.com/software. You will need ZebraNet Bridge Enterprise version 1.2.5 or later to configure the printer correctly for use.



NOTE: You can set up only one print server at a time with the Connectivity Wizard. To configure multiple print servers (wired and wireless), run the program one time to set up each print server.

Configuring Your Printer using the Connectivity Wizard

1. If it is not already installed, install ZebraNet Bridge Enterprise on your computer.
The install file can be downloaded from the Zebra website at zebra.com/software.
2. Launch the ZebraNet Bridge Enterprise program. If you are prompted for a serial number, you may click **Cancel** and continue with the installation.
3. From the Menu bar, select **Tools > Connectivity Wizard**.

The Connectivity Wizard opens.

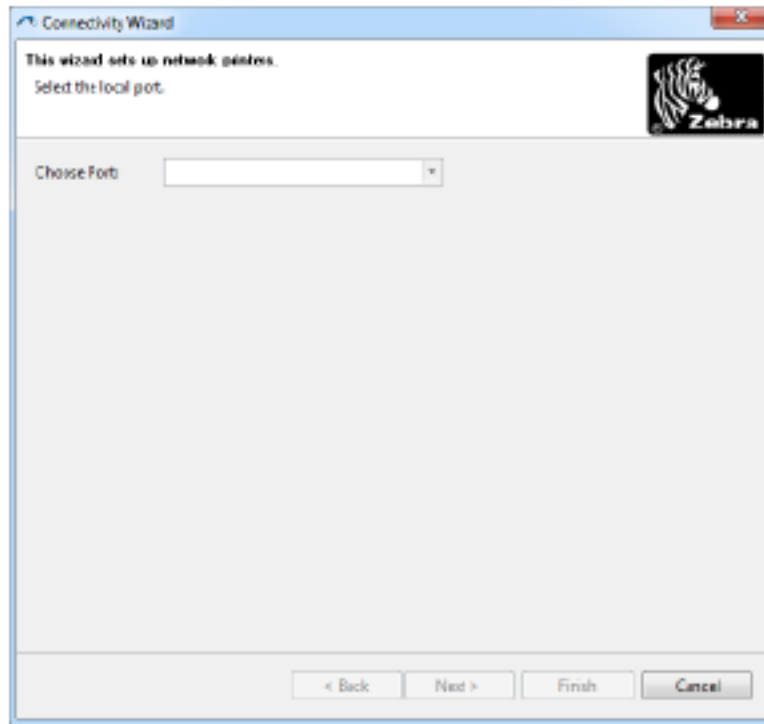

4. From the **Choose Port** list, select the port to which your printer is connected.
 - If you will save the file without sending it to the printer, select any available port.
 - If you select **File**, you will be asked to browse to the location of the file you want to save.
 - If you select a serial port, the serial configuration information appears below the **Choose Port** list. If necessary, change the serial communication settings to match your printer's settings.



NOTE: If a port is in use by another device, it will not be included in the drop-down list.

5. Click **Next**.

The wizard prompts for the print server device to configure.

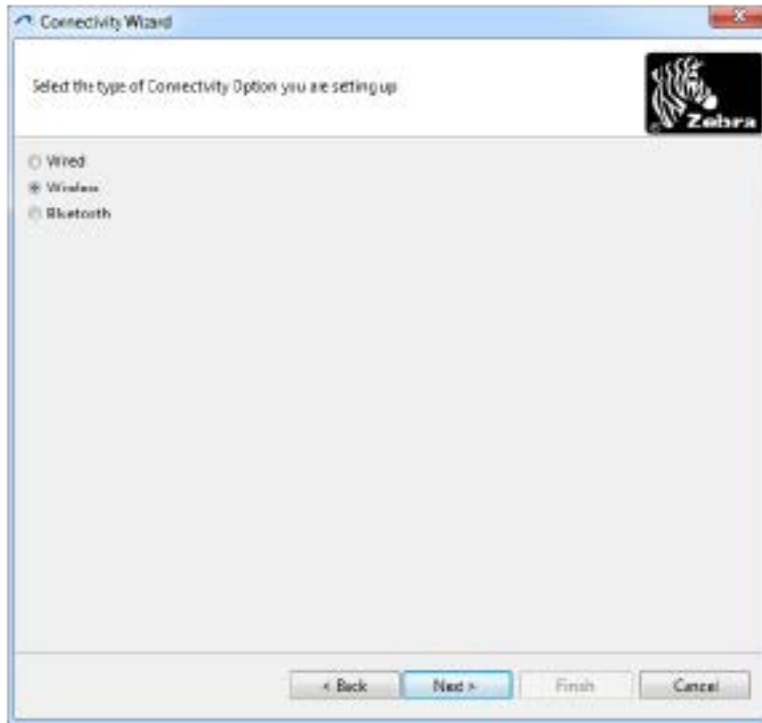

6. Select **Wireless**, then click **Next**.

The wizard prompts you for the type of printer you are using.

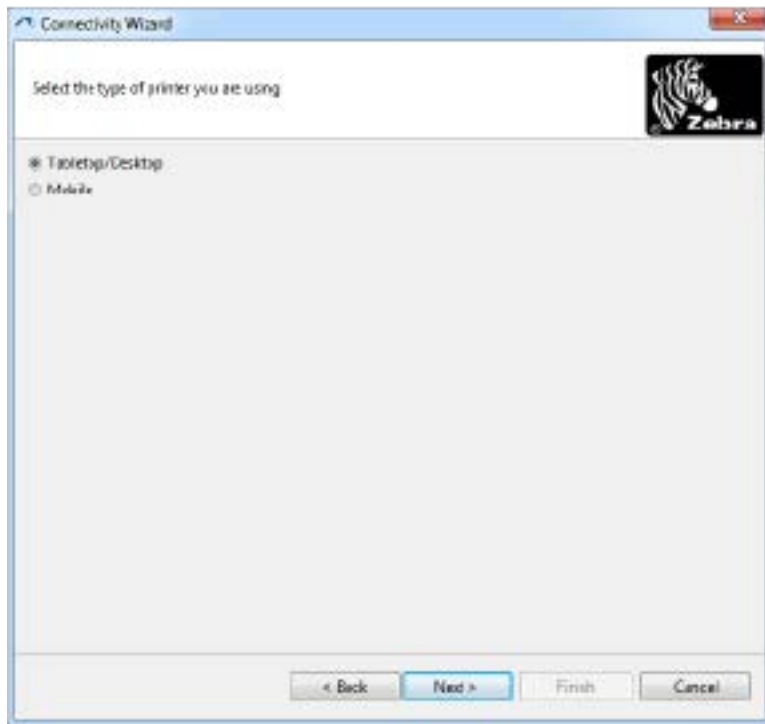

7. Select the type of printer you are using and click **Next**.

The wizard prompts you for the wireless IP information.

Connectivity Wizard

Select how you want the print server to obtain an IP address.

IP Settings
How do you want the print server to obtain an IP address?

DHCP

Static

IP Address:

Subnet Mask:

Default Gateway:

Client ID Settings

Enabled: Off

Type: MNC ADDRESS

Prefix:

Suffix:

< Back Next > Finish Cancel

8. Enable either the **DHCP** (dynamic) IP or the **Static** IP option.
 - DHCP: Select **DHCP** and click **Next**.
 - Static (IP): Select **Static** to activate the **IP Settings** fields. Then enter the **IP Address**, **Default Gateway**, and **Subnet Mask** for the wireless print server (which you can obtain from your network administrator). When done, click **Next**.

The Wireless Settings window opens.

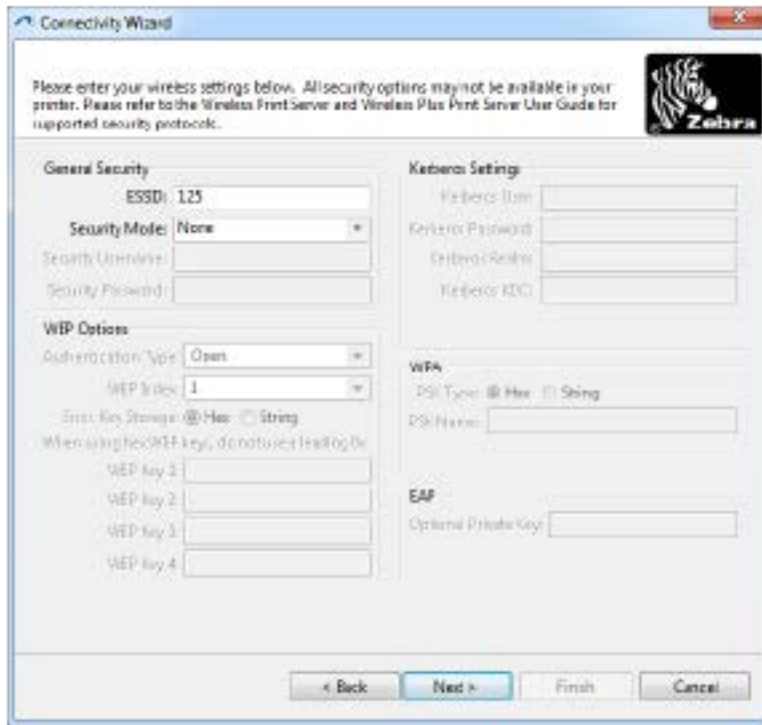

9. Enter the **ESSID**.



NOTE: If you plan to use an ESSID and a passphrase, they must be set at your access point before completing these steps.

10. From the dropdown menu, select the **Security Mode** you plan to use.

None	No security protocol selected.
WEP 40-Bit or WEP 128-Bit	In the WEP Options section of the window, enter the Authentication Type , WEP Index , Encryption Key Storage , and WEP Keys , then click Next and continue with the next step in this task.
EAP-TLS, EAP-TTLS, EAP-FAST, or WPA-EAP-TLS	In the EAP section of the window, if necessary, enter the Optional Private Key , then click Next and continue with the next step in this task.
PEAP, LEAP, WPA-EAP-TTLS, WPA-PEAP, or WPA-LEAP	In the General Security section of the window, enter the Security Username and Password , then click Next and continue with the next step in this task.
WPA-PSK	In the WPA section of the window, select the PSK Type and enter the PSK Name , then click Next and continue with the next step in this task.

WPA-EAP-FAST	In the General Security section of the window, enter the Security Username and Password , and in the EAP section of the window, if necessary, enter the Optional Private Key . Click Next and continue with the next step in this task.
KERBEROS	In the Kerberos Settings section of the window, enter the Kerebros User ID , Kerebros Password , Kerebros Realm , and Kerebros KDC . Then click Next and continue with the next step in this task.  NOTE: KERBEROS is NOT supported on Internal Wireless Plus print servers or radio cards.

- In the Wireless Settings window, click **Advanced Options**.

The Advanced Wireless Settings window opens.

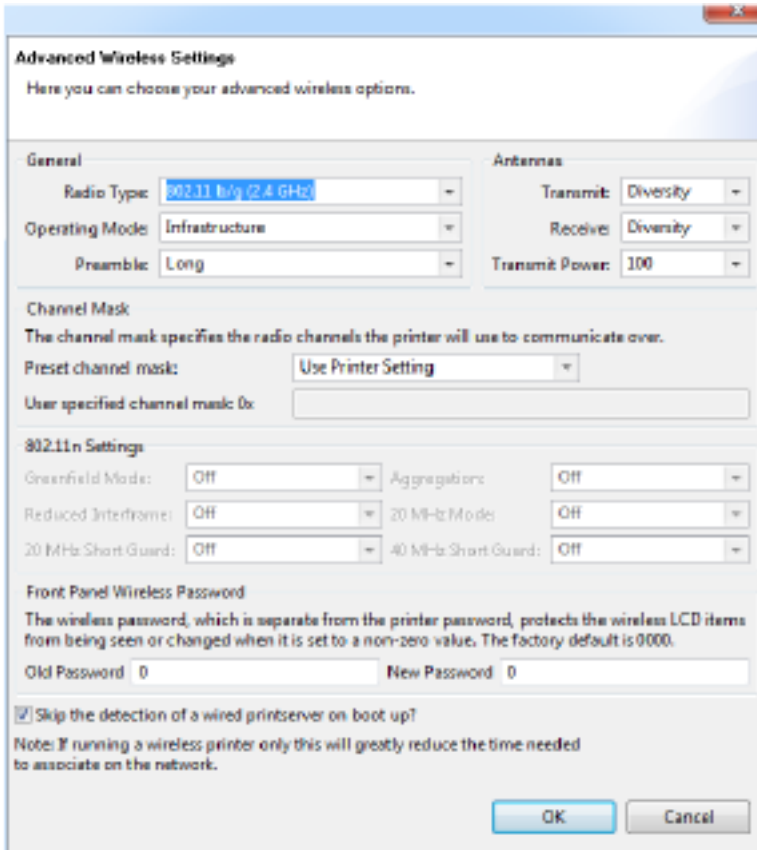

- Review the settings in the Advanced Wireless Settings window, change them as necessary, and click **OK**.

The Wireless Settings window shows again.

- Click **Next**. Based on your selections in the Wireless Setup Wizard, the program writes the appropriate ZPL commands and displays them for your review. If you selected **Tabletop/Desktop**, a dialog box displays that will be similar to the one below.

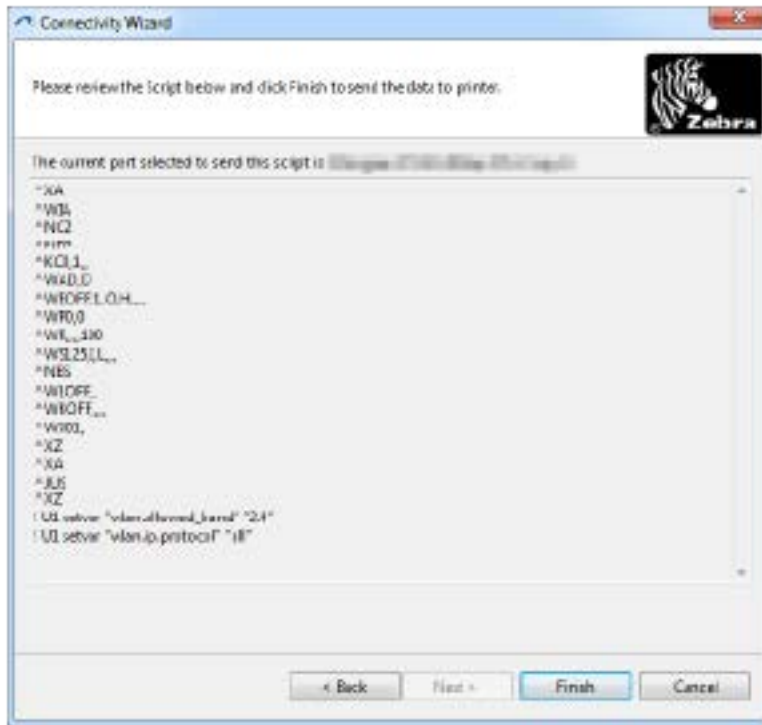

- Decide if you will send the script immediately or save it for use at a later time. This information will be needed subsequently in the setup process.

Completing Setup Using a Configuration Script

If you opted to send a ZPL script to the printer (through the port you selected in the setup wizard) to complete the setup, use these steps.

- Verify that the printer is connected to the computer through the wired cable connection to port you selected (USB or Serial).
- If you have not already done so, turn printer power ON.
- On the Review and Send ZPL for Wireless window, click **Finish**.

The printer sends the ZPL script to the printer through the selected port. The Wireless Setup Wizard screen closes.

- Turn printer power OFF and then back ON to complete the setup.

Saving a Configuration Script

Save the ZPL script to a file for use later or for use with other printers.



NOTE: You can send the ZPL script file to multiple printers that use the same configuration, or you can send the file to a printer that had the network settings restored to the factory defaults. This saves you from having to go through the Wireless Setup Wizard more than once.

- On the Review and Send ZPL for Wireless window, highlight the script, right-click, and select **Copy**.
- Open a text editor, such as Notepad, and paste the script into the application.

3. Save the script.
4. In the Connectivity Wizard, click **Cancel** to exit without sending the script at this time.
5. If you have not already done so, turn printer power ON.
6. Send the ZPL file to the printer through the connection of your choice.
7. Observe the wireless status on the printer's indicator lights, and confirm that you have set up your printer for wireless connectivity.

Configuring Your Printer using the Bluetooth Option

The Zebra Setup Utilities provides a quick and easy way to configure a Bluetooth wireless connection with your printer.

1. Double-click the Zebra Setup Utilities icon on your desktop.
2. Connect a USB cable from your printer to your computer.
3. On the first ZSU screen, highlight the printer displayed in the window and click on the **Configure Printer Connectivity** where shown.
4. On the Connectivity Type screen, select **Bluetooth**, then click **Next**.

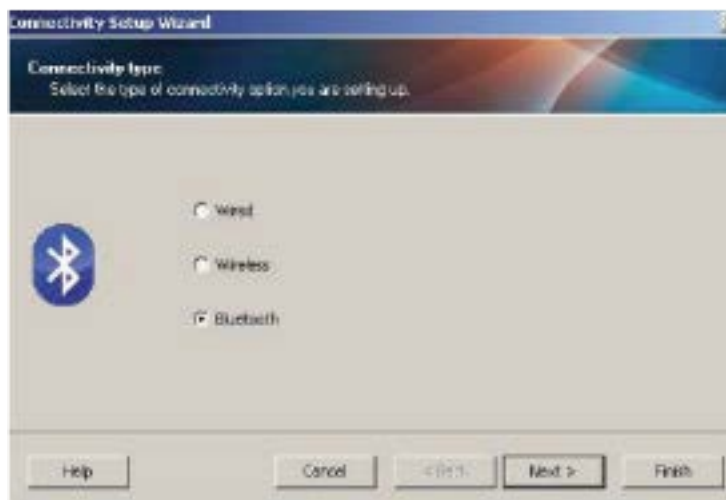

5. On the Bluetooth Settings screen, check **Enabled** to enable Bluetooth functionality.
6. In the Friendly Name text field, set the Bluetooth name of the device. This name appears during device discovery and the master device will label the printer with this name.
7. Set **Discoverable** to On or Off to set whether the device will appear when master devices are looking for new devices to pair with.
8. Set **Authentication** to On.



NOTE: This setting does not exist in Link-OS, but you will need to turn it on if you want to enter a PIN in Zebra Setup Utilities. Access **Security Mode** on the Advanced Settings menu to enter this PIN.

9. The values set in the Authentication PIN field will vary depending on the Bluetooth (BT) version of the master device. If the master uses BT v2.0 or older, enter a numeric value in this field. You will be

prompted to enter this same value on the master device to verify pairing. In Advanced Settings, select **Security Mode 2 or 3** for PIN pairing.

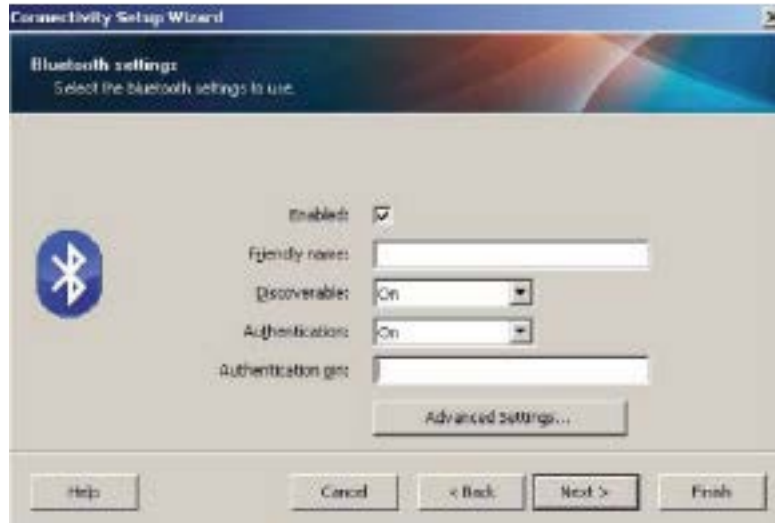

If the master device uses BT v2.1 or newer, this setting has no effect. BT v2.1 and newer uses Secure Simple Pairing (SSP) which does not require the use of a PIN.

10. Click on the **Advanced Settings** button.

The Advanced Bluetooth Settings window displays.

For more information on Advanced Settings, refer to the Wired and Wireless Print Server Guide.

11. Click **Next** to continue configuring your printer.

SGD commands needed to properly configure your printer will be displayed.

12. Click **Next** to continue.

The Send Data screen displays.

13. Click on the name of the printer that you want to send the commands to, then click **File** to save the commands to a file for reuse later.

14. Click **Finish** to send the commands to the printer.

The printer updates and reboots.



NOTE: You may disconnect the USB interface from your printer now.

15. To complete the Bluetooth pairing process, enable Bluetooth device discovery on the PC or device you use to manage the printer and follow the on-screen instructions.

Connecting the Printer to a Windows 10 PC

Before adding (pairing) a Bluetooth-enabled device to the printer, make sure it is turned on and discoverable.



NOTE: Your Windows device may need a Bluetooth adapter to connect to Bluetooth device. Check with your device manufacturer's User Manual for further information.

Setup for Windows PC or Other Device Communications

1. Click the Windows Start () button and select **Settings**.

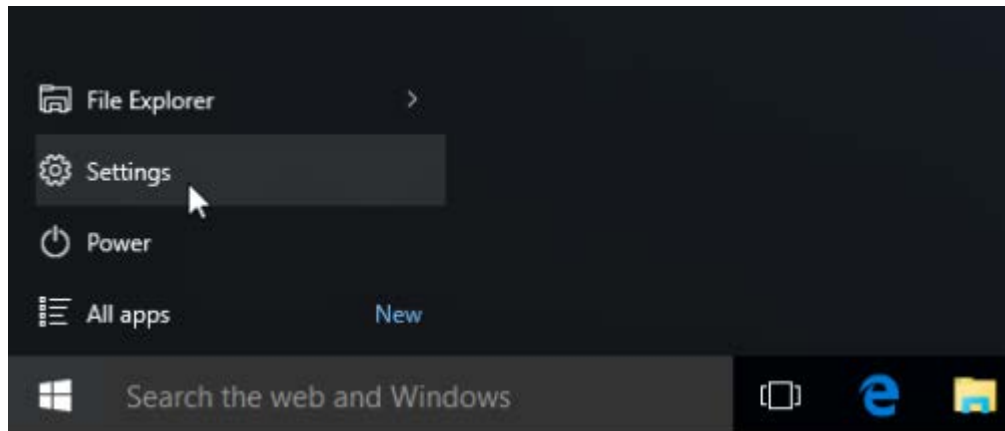

2. In the Settings window, click **Devices**.

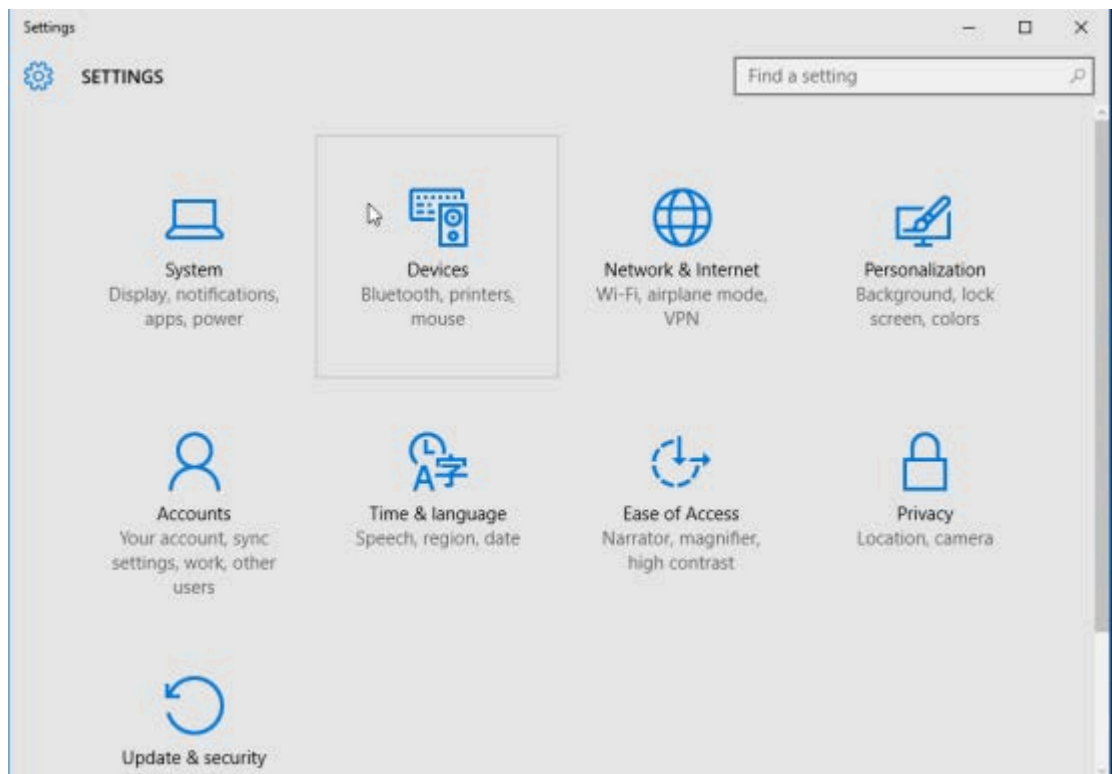

3. Click **Bluetooth**.



NOTE: If your PC doesn't have Bluetooth installed, the Bluetooth category will not be displayed in the list of device categories.

The printer is identified by the serial number.

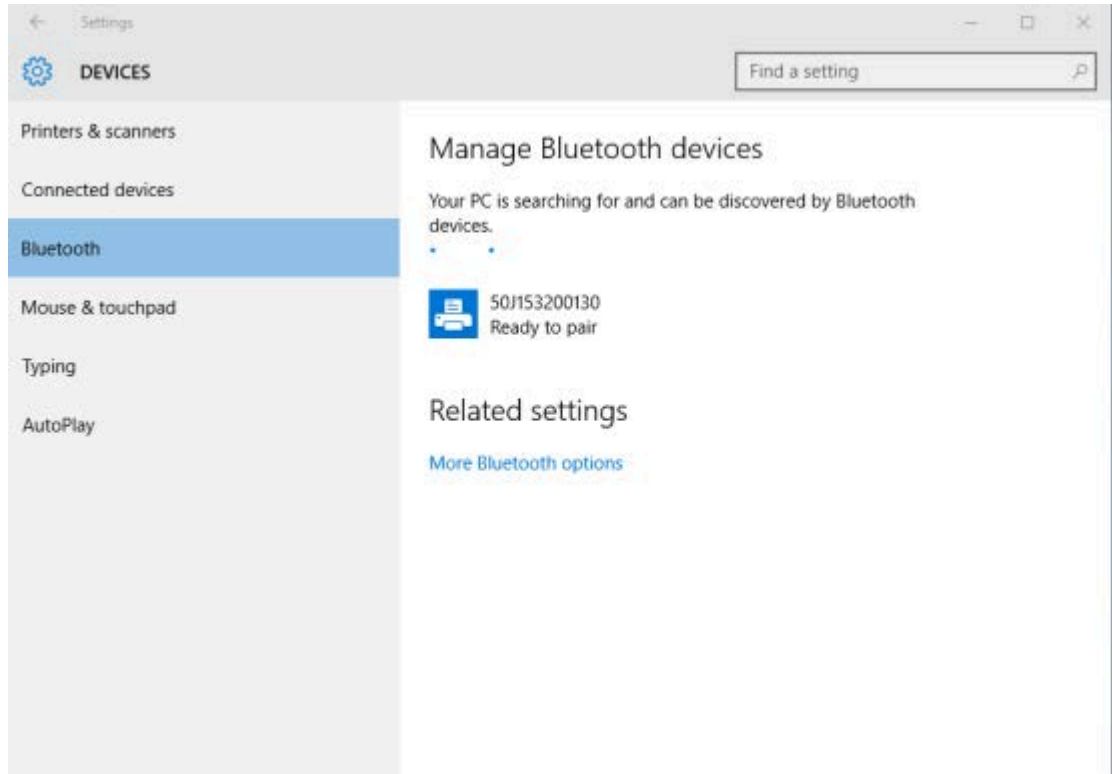

4. Click on the printer icon, then click **Pair**.

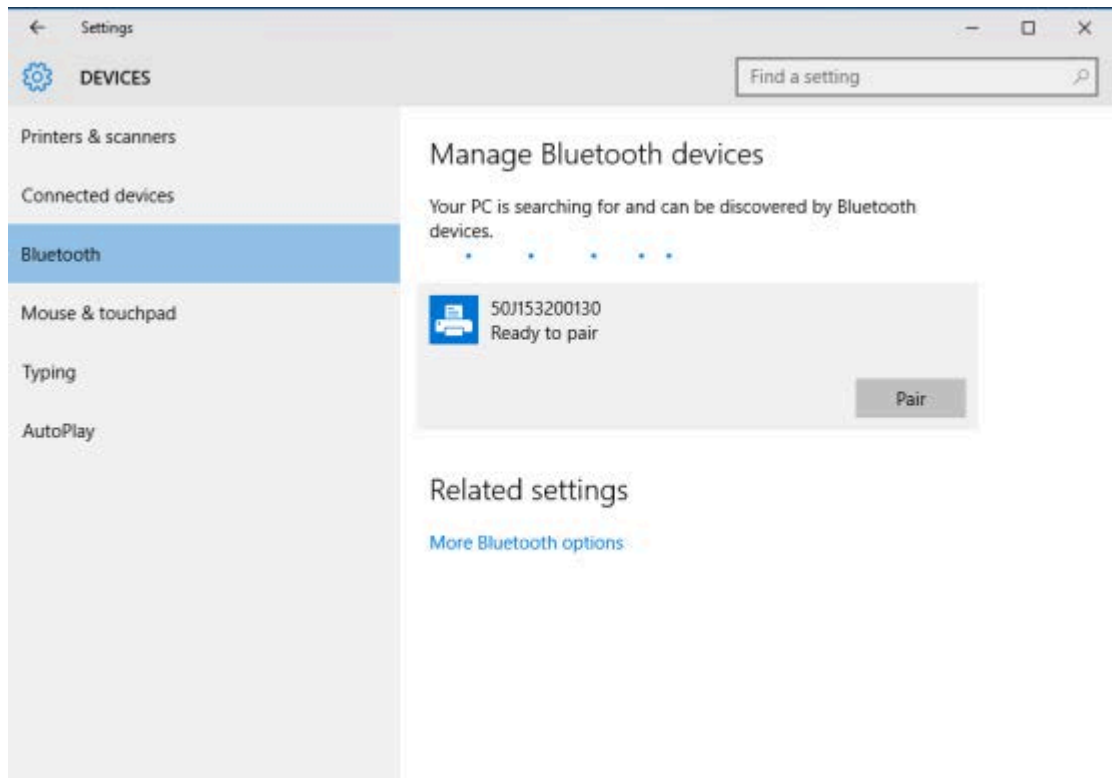

The printer prints a passcode.

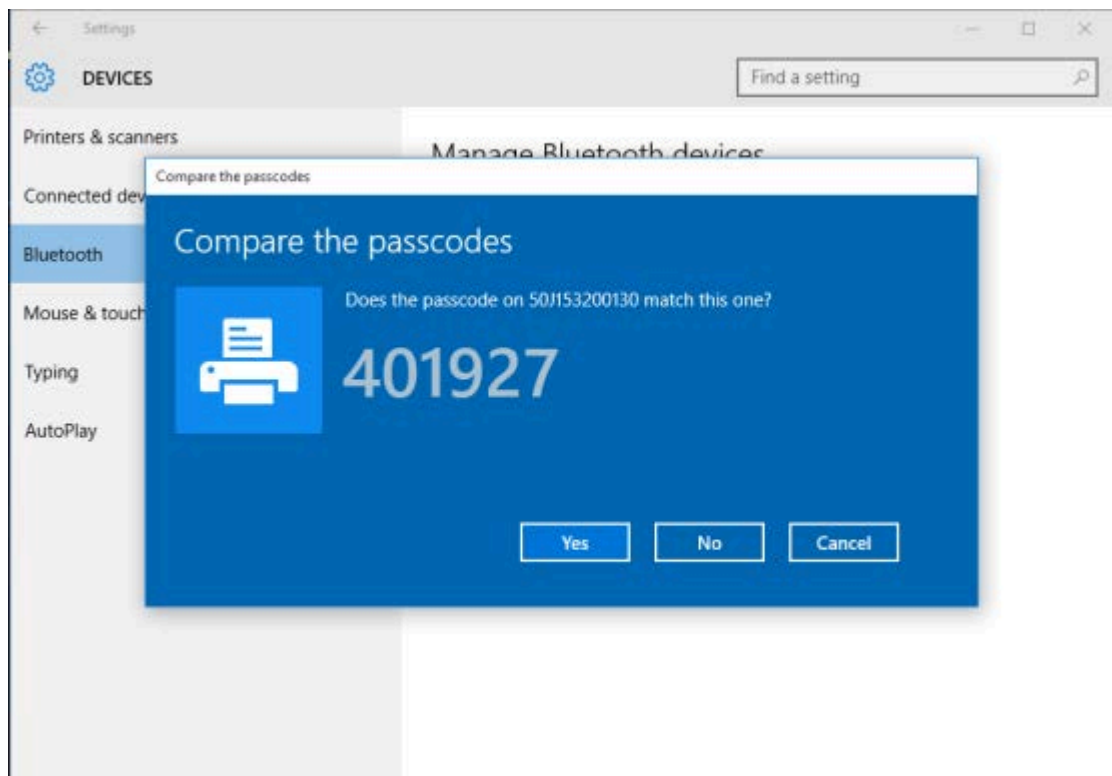

5. Compare the passcode printed by the printer to the passcode shown on the screen. Click **Yes** if they match.

When the computer and printer are paired, the printer's status in the Devices window changes to 'Connected' as shown here.

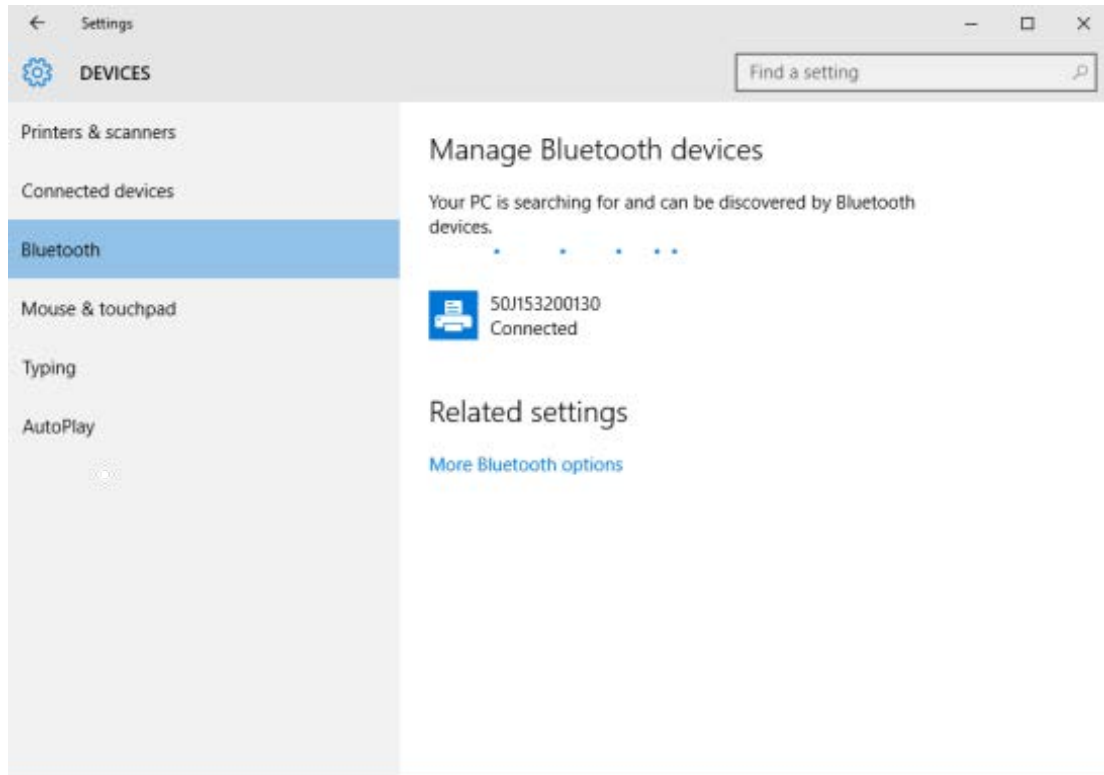

After Your Printer is Connected

Now that you have basic communication to your printer, you may want to test printer communications and then install other printer related applications, drivers or utilities.

Test Communications by Printing

Verifying the print system's operation is a relatively simple process. For Windows operating systems, use the Zebra Setup Utility or the Windows Printers and Faxes (from the Control Panel) to access and print a test label. For non-Windows operating systems, copy a basic ASCII text file with a single command (~WC) to print a Printer Configuration label.

Test-Printing with Zebra Setup Utility

1. Open the Zebra Setup Utility.
2. Click the newly installed printer's icon to select the printer.
3. Click **Open Printer Tools**.
4. In the Print tab, click **Print configuration label**, then click **Send**.

The printer prints a configuration report.



NOTE: If the report does not print, see [Troubleshooting](#) on page 133.

Test-Printing with Windows Printer and Faxes menu

1. Click the Windows **Start** button and access **Devices > Printers and Faxes**.
2. Right-click the newly-installed printer's icon and click **Properties**.
3. From the General tab, click **Print Test Page**.

The printer prints a configuration report.



NOTE: If the report does not print, see [Troubleshooting](#) on page 133.

Test Printing with an Ethernet Printer Connected to a Network

Test print on an Ethernet printer connected to a wired or wireless network (LAN or WLAN) with a command prompt (or search for and click **Run** from the Windows Start menu):

1. Create a text file with the following characters: `~WC`
2. Save the file as `TEST.ZPL`, or use any other arbitrary file name and extension.
3. On the printer's Configuration Report's Network Status printout, identify the IP address of the printer.
4. In a web browser window address bar, on a system that is connected to the same LAN or WAN as the printer, type `ftp` followed by the printer's IP address.

For example, if the printer's IP address is `123.45.67.01`, type `ftp 123.45.67.01`.

The printer should print a new print configuration report.



NOTE: If the report does not print, see [Troubleshooting](#) on page 133.

Test-Printing with a Copied ZPL Command File for Non-Windows Operating Systems

1. Create a text file that has the following characters: `~WC`
2. Save the file as `TEST.ZPL` (or use any filename and extension name).
3. Copy the file to the printer.

For DOS, if the printer is connected through a serial port connection, type `COPY TEST.ZPL COM1` on a blank command line, then press **Enter** to send the command.



NOTE: Other interface connection types and operating systems will have different command strings. See your operating system documentation for detailed instructions on how to copy the command to the appropriate printer interface for this test.

The printer should print a configuration report.



NOTE: If the printer does not print the test report, see [Troubleshooting](#) on page 133.

What To Do If You Forget to Install the Printer Drivers First

1. Follow the instructions in [Pre-install Windows Printer Drivers](#) on page 66 to download and install the drivers on your laptop.
2. From the **Windows** menu, open the **Control Panel**.
3. Click **Devices and Printers**.

In this example, the ZTC ZT320-203dpi ZPL is an incorrectly installed Zebra printer.

▼ **Unspecified (1)** -



ZTC
ZT230-203dpi
ZPL



NOTE: You can verify your printer's model number and print resolution (for example, 203dpi) using the test print of the Configuration Report label from the top of the report. (See [Printing a Test \(Printer Configuration\) Label](#).)

4. Right-click on the icon representing the device, then select **Properties**.

The properties for the device display.

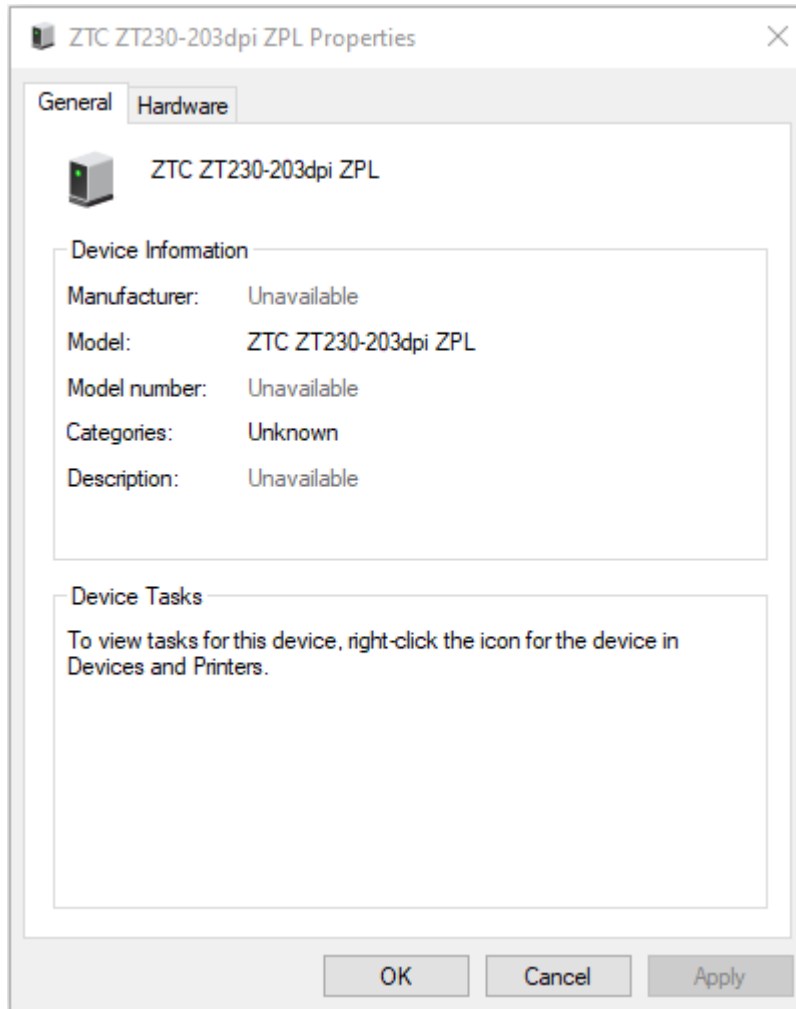

5. Click the **Hardware** tab.

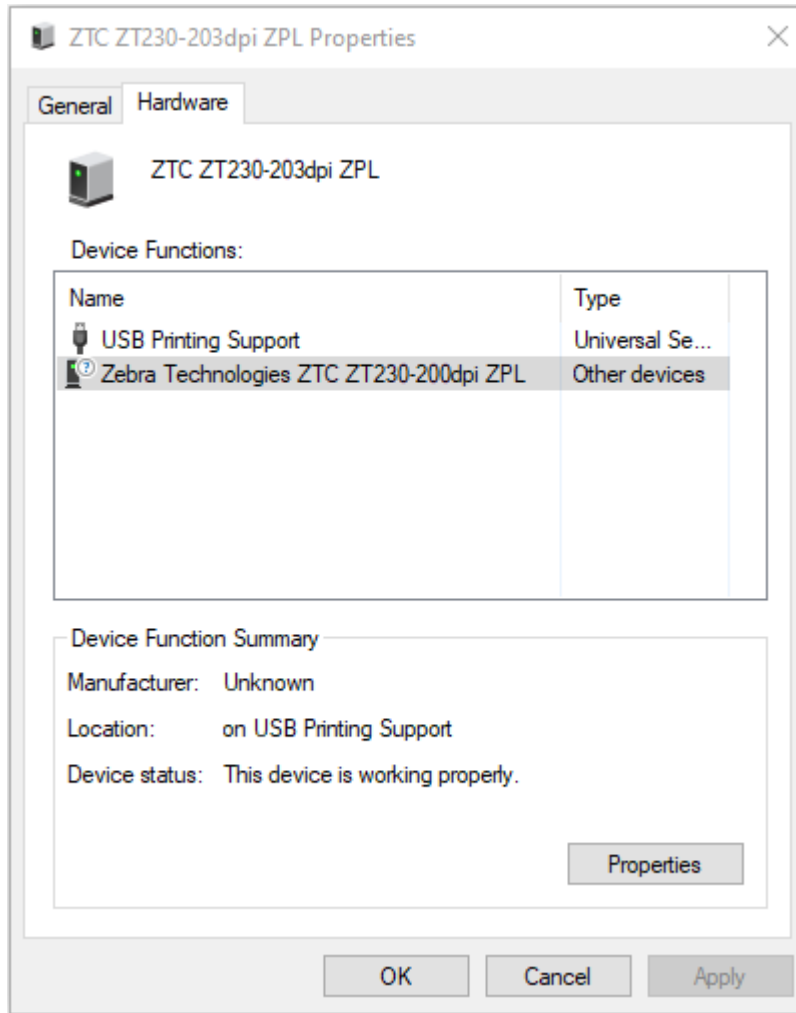

6. Select the printer in the **Device Functions** list, then click **Properties**.

The properties display.

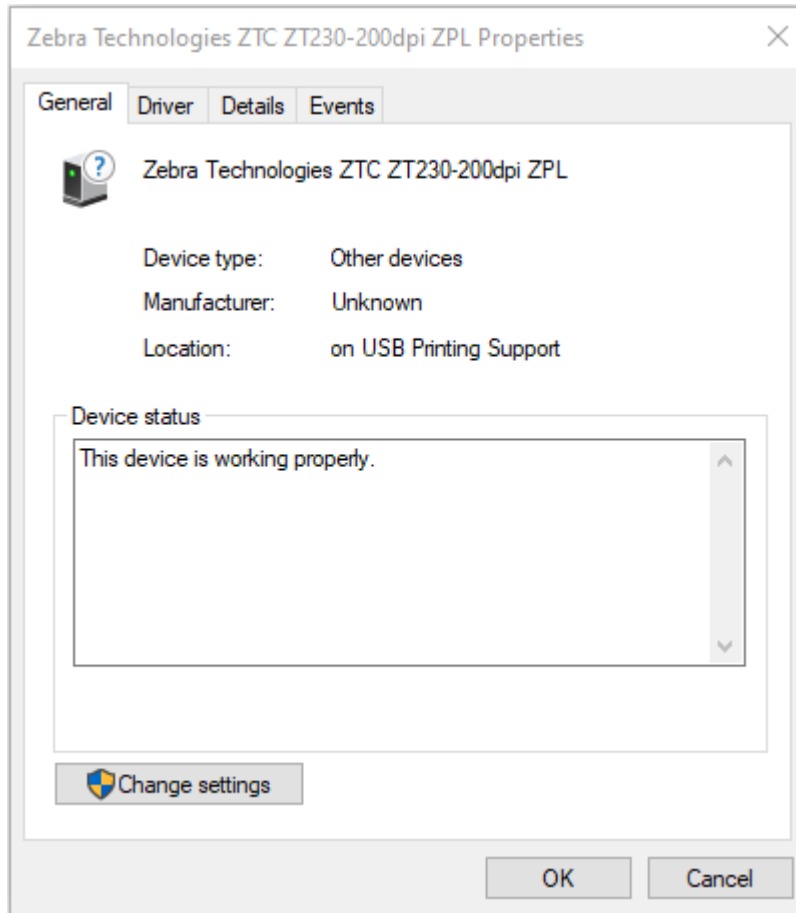

7. Click **Change settings**, then click the **Driver** tab.

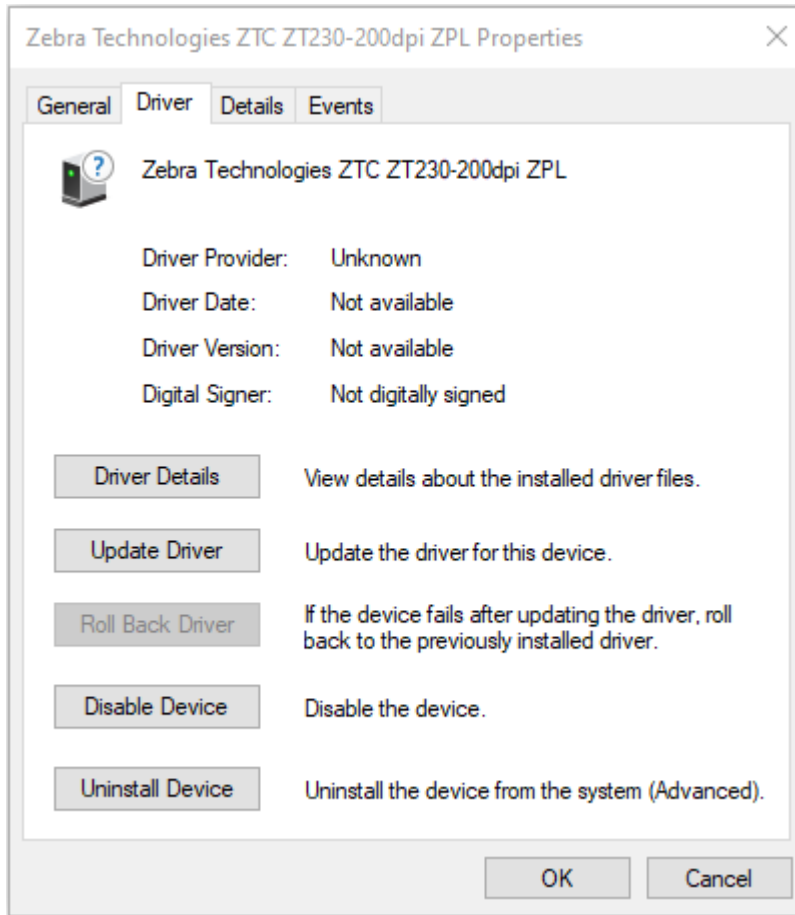

8. Click **Update Driver**.

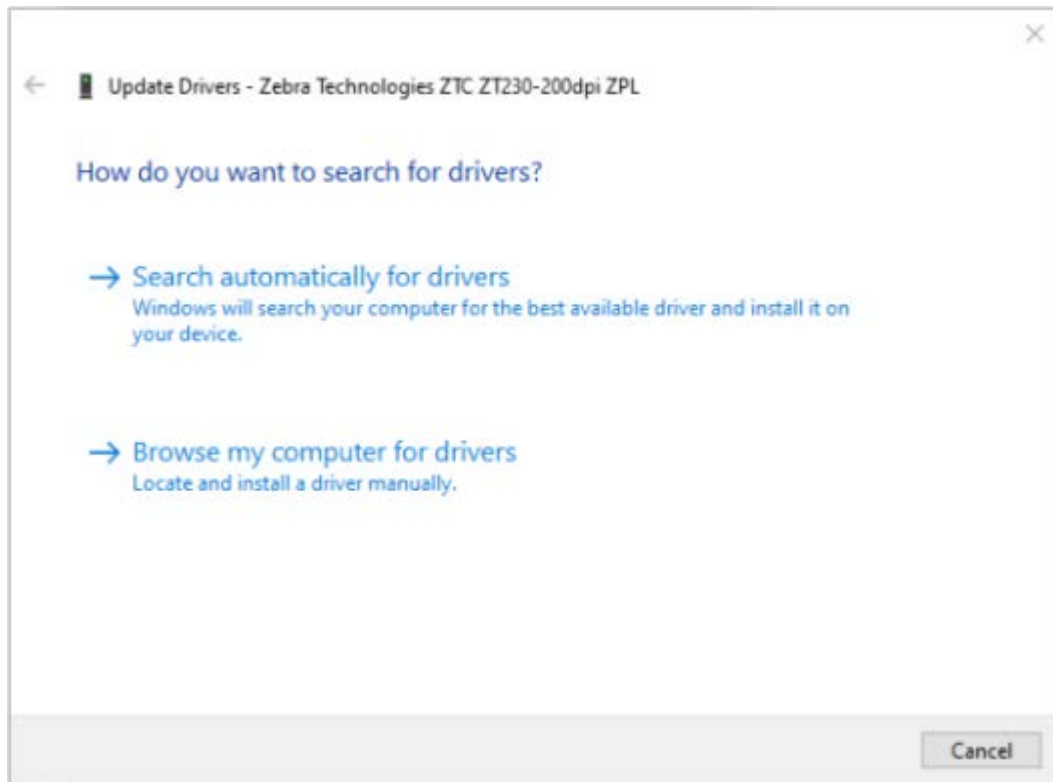

9. Click **Browse my computer for driver software**.
10. Click **Browse...** and navigate to the **Downloads** folder.

11. Click **OK** to select the folder.

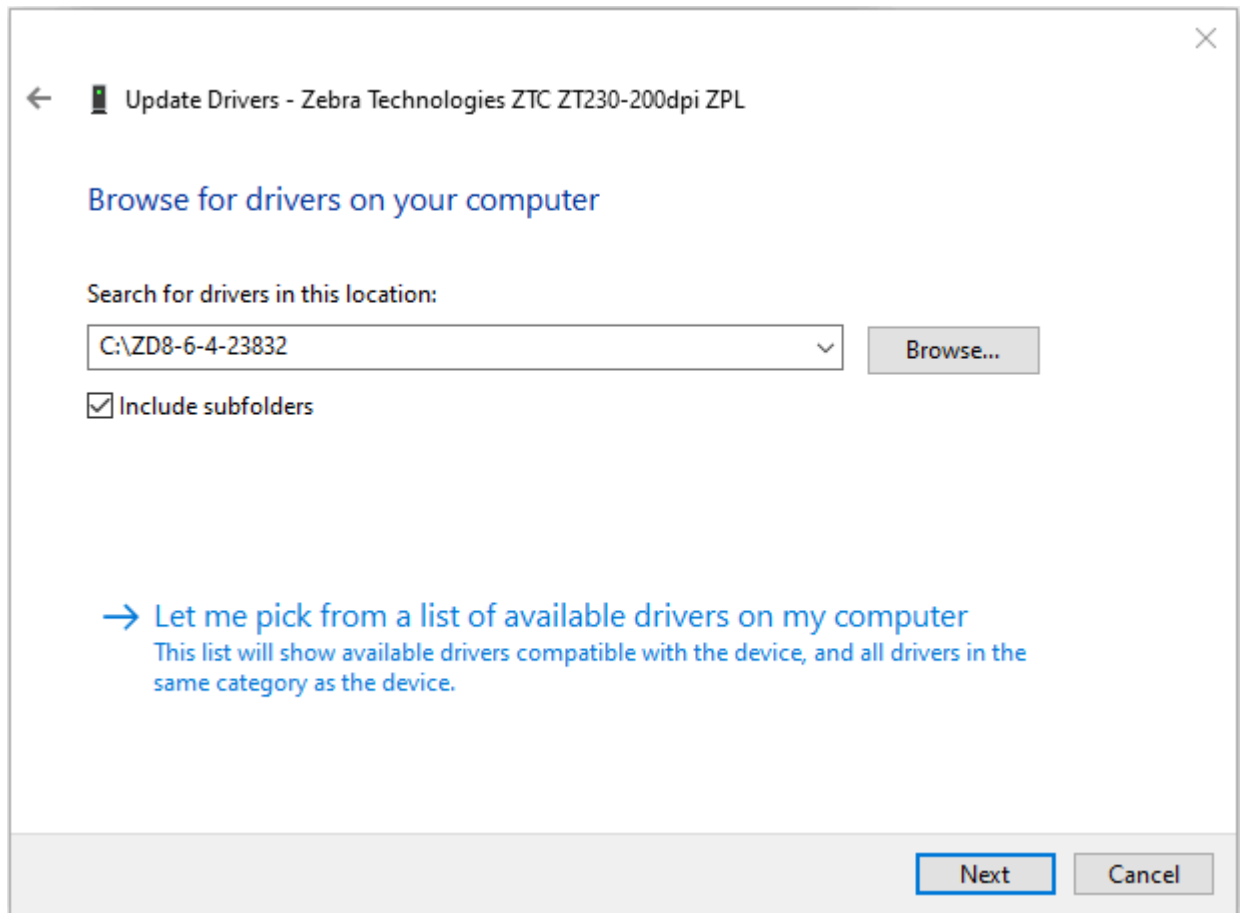

12. Click **Next**.

The printer is updated with the correct drivers.

Print Operations

This section provides general information on media and print handling, font and language support, and the setup of less common printer configurations.

Thermal Printing

The ZD Series printers use heat to expose direct thermal media or heat and pressure to melt and transfer 'ink' to the media. Extra care should be taken to avoid touching the printhead which gets hot and is sensitive to electrostatic discharges.



CAUTION: The printhead becomes hot while printing. To protect from damaging the printhead and risk of personal injury, avoid touching the printhead. Only use the cleaning pen to perform printhead maintenance.



CAUTION—ESD: The discharge of electrostatic energy that accumulates on the surface of the human body or other surfaces can damage or destroy the printhead and other electronic components used in this device. You must observe static-safe procedures when working with the printhead or the electronic components under the top cover.

Determine Your Printer's Configuration Settings

The ZD410 printer uses the configuration report to provide the printer settings. Operational status (darkness, speed, media type, etc.), installed printer options (network, interface settings, cutter, etc.) and printer description information (serial number, model name, firmware version, etc.) are all included on the configuration report.

See [Testing Printing with the Configuration Report](#) on page 59 to print this label.

See [ZPL Printer Configuration Format and Reusable Files](#) on page 168 to help interpret the configuration report and the associated programming command and command states it is identifying in the report.



Replace Supplies

If the printer runs out of media (labels, receipt, tags, tickets, etc.) while printing, leave printer power ON when you reload media. If you turn printer power OFF, you will lose any print job that was in process when the printer ran out of media supplies.

To restart an in-process print job after loading media, press **FEED** ().

Detect a Media Out Condition

When you run out of media, your printer will report a Media Out condition with the Status indicators. This is part of the normal media usage cycle.

When the printer detects that it has run out of media to print, the Status indicator () and the Media indicator () both turn solid red.

Load media to continue printing. See [Loading Media](#) on page 49 and [Loading Roll Media](#) on page 53.

Recovering from a Media Out condition

1. Open the printer.
2. Observe that the media is at the end or nearly at the end of the roll, with a label missing from the liner.
The printer typically stops before the adhesive or tape used to attach media to the roll core gets to the printhead.
3. Remove the remaining media and roll core.
4. Insert a new roll of media. See [Roll Media Sensing and Media Loading](#) on page 48.
 - If you are installing more of the same media, load the new media and press **FEED** () one time to resume printing.
 - If you are loading media that is different from the one previously loaded in terms of size, vendor, or batch, you must load the media and then perform a SmartCal procedure to ensure optimal operation. See [Running a SmartCal Media Calibration](#) on page 58).
 - Changing media size (length or width) usually requires you to change the programmed media dimensions or the active label format in the printer.



IMPORTANT: Sometimes a label may be missing somewhere in the middle of your roll of labels and not at the tail end. This will also cause a Media Out condition. To recover, pull the media past the missing label until the next label is over the platen roller. Close the printer and press **FEED** () one time. The printer resynchronizes the label position in readiness to resume printing.

Select a Print Mode

Use a print mode that matches the media being used and the printer options available.

To set the printer to use an available print mode, see the `^MM` command in the ZPL Programmer's manual. The manual is available from zebra.com/support.



NOTE: Roll media and fanfold media use the same media path during printing.

Print Modes

<p>TEAR OFF (default mode)</p>	<p>This mode can be used with any printer options and most media types. The printer prints label formats as it receives them. The printer operator can tear off the printed labels any time after they print.</p>
--------------------------------	---

PEEL (available only with the Label Dispenser option)	The printer peels the label from the liner during printing and then pauses until the label is removed.
CUTTER (available only with the Cutter option)	The printer cuts between labels after each one is printed.

Adjust the Print Quality

Print quality is affected by the heat (density) setting of the printhead, the print speed, and the media in use. Experiment with these settings to find the optimal mix for your application. Print quality can be configured with the Zebra Setup Utility's Configure Print Quality routine.



NOTE: Media manufacturers may have specific recommendations for speed settings for your printer and the media. The recommended speed may be lower than your printer's maximum speed setting!

The darkness (density) setting can be controlled by:

- issuing the Set Darkness (look up the ~SD) ZPL command in the ZPL Programming Guide).
- adjusting the print darkness (see [Manual Print Darkness Adjustment](#) on page 153)..
- adjusting the physical darkness control setting (see [Darkness Control](#) on page 96).

If you find that the print speed needs to be adjusted, use:

- the Windows printer driver or application software such as ZebraDesigner.
- the Print Rate or ^PR) ZPL command (consult your ZPL Programming Guide)

Use the printer's Print Quality Report (FEED Self Test) to print a range of labels that help you identify print darkness and speed settings for optimizing general print and barcode quality. See [Printing a Print Quality Report \(FEED Self-Test\)](#) on page 144 for details.

To verify the printer's media settings, print a Printer Configuration label following the instructions in [Testing Printing with the Configuration Report](#) on page 59.

The maximum distance the automatic media type detection and sensing checks can be reduced using the ZPL Maximum Label Length command (^ML). The minimum distance should be no less than two times the longest label being printed. If the largest label being printed was a 2 x 6 in. label, the maximum label (media) length detection distance can be reduced from the default distance of 39 in. down to 12 in.

Darkness Control

The **Darkness Control** switch enables you to modify the darkness setting for minor variations in media and printers without having to change the program or driver settings sent to the printer.

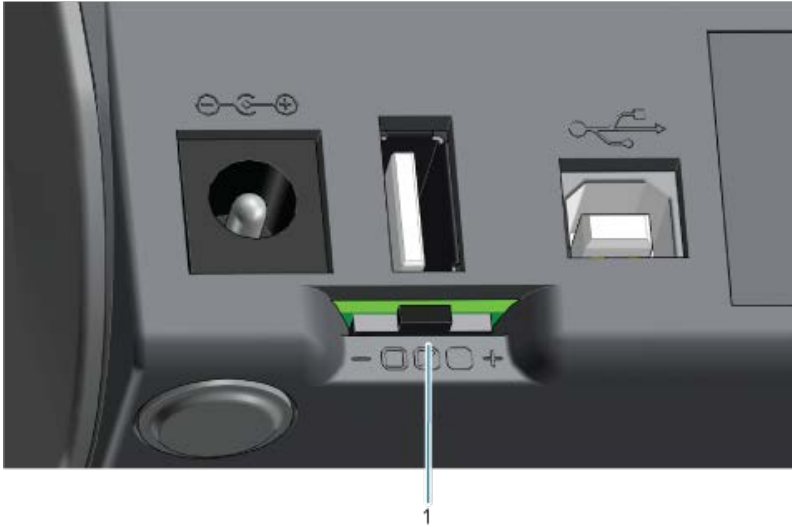

The darkness control switch has three settings:

Left	No effect (default). Makes no change to the darkness setting as set by programming or driver setting.
Middle	increases darkness by three levels (medium). For example, if the printer is set to the default darkness level of 20, the actual darkness applied while printing will be 23.
Right	Increases darkness by six levels (high).



IMPORTANT: Setting the print darkness too high or too low may reduce barcode readability.

Printing on Fanfold Media

Printing on fanfold media requires you to adjust the media guides stop position.

1. Open the top cover.



2. Adjust the media guide stop position with the gold thumb wheel. Use a piece of the fanfold media to set the stop position. Rotate the wheel away from you to make the guides wider. Rotate the wheel toward you to make the media guides narrower.

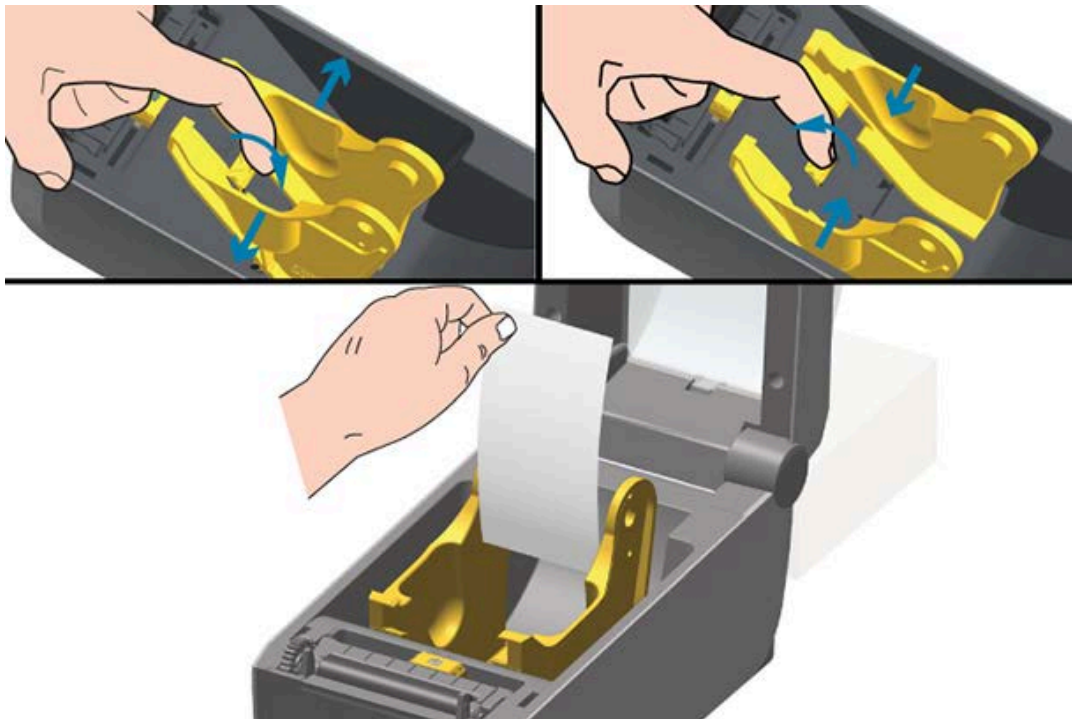

3. Insert the media through the slot at the rear of the printer and place the media between the media guide and roll holders.



4. Close the top cover.
5. If, after the printer prints or feeds several labels, you notice that the media does not track down the center (moves from side to side) or if the sides of the media (liner, tag, paper, etc.) are frayed or damaged when exiting the printer, you may have to adjust the media guides. If this does not correct the problem, you can route the media over the two roll holding pins on the media guide. For thin media, you can place an empty roll core of the same width as the stack of fanfold media between the roll holders to provide additional support.

Print with Externally-Mounted Roll Media

The printer accommodates externally-mounted roll media similar to the printer's support of fanfold media. The printer requires the media roll and stand combination to have low-enough initial inertia to pull the media off the roll.



NOTE: At this time, Zebra does not offer an external roll media option for the ZD410 printer.

Externally-Mounted Roll Media Considerations

- Ideally, the media should enter the printer from directly behind the printer through the fanfold media slot in the rear of the printer. See [Printing on Fanfold Media](#) on page 97.
- Lower the print speed to decrease the chance of motor stalls. The roll typically has the highest inertia when trying to start the roll moving. Larger media roll diameters require the printer to have more torque applied to get the roll moving.
- The media should move smoothly and freely. It should not slip, skip, jerk, bind and then move, etc. when mounted on your media stand.
- The printer should not touch the media roll.
- The printer should not slip or lift up off the operating surface.

Using the Label Dispenser Option

The label dispenser option allows you to print a label and have the backing material (liner/web) automatically removed when the label exits the printer. If you are printing multiple labels, removing one dispensed (peeled) label triggers the printer to print and dispense the next label.

To use dispenser-mode:

- In the printer driver, set *Media Handling* to *Peel-Off*.
- In the Zebra Setup Utilities, use the *Configure Printer Settings* wizard to change this setting.
- Send the ZPL programming commands to the printer.

When programming in ZPL, use the command sequences `^XA ^MMP ^XZ` and `^XA ^JUS ^XZ` to configure the printer to use the dispenser option:

1. Load your labels into the printer. Close the printer and press **FEED** () until a minimum of 100 mm or four in. of exposed labels exit the printer. The labels can be left on the liner.





2. Lift the liner over the top of the printer. Pull the gold latch in the center of dispenser door away from the printer.

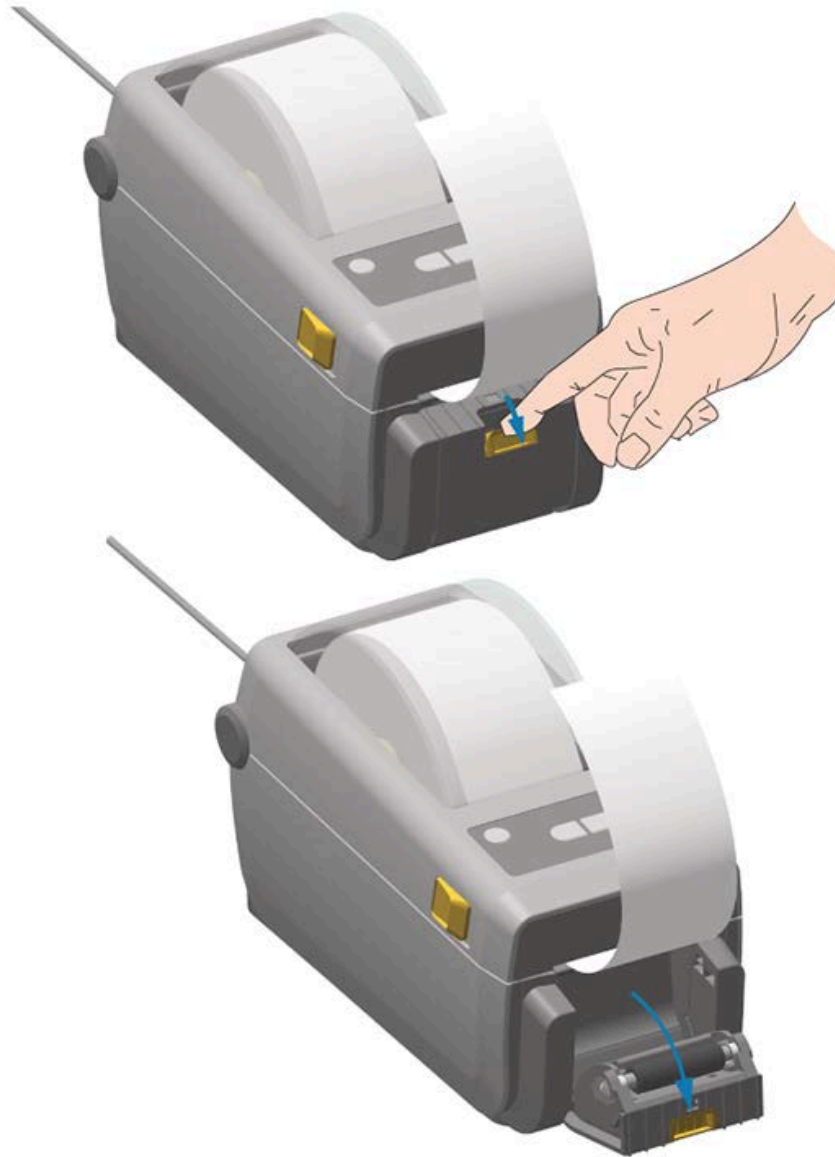

The door opens.

3. Insert the label liner between the dispenser door and the printer body.



4. Close the dispenser door while pulling the end of the label liner tight.



5. Press and release **FEED** () one or more times until a label gets presented for removal. Repeat one more times, then tear the exposed liner exiting from the lower part of the label dispenser.



6. Take each dispensed label from the printer during a print job to allow the printer to print the next label.



NOTE: If you did not activate the label-taken sensor to detect the removal of the dispensed (peeled) label with software commands, the printer stacks and ejects the peeled labels.

Print with the Attached Battery Base and Battery Option

Printer operations are slightly different when using the battery due to the difference in power connections and power loss scenarios. The battery is designed to maximize battery life, maintain print quality, and enable simple operations.

- When you connect the printer's external power supply to the battery, you wake up the battery. The battery then automatically determines if charging is needed.
- The battery will not start charging until its charge level is below 90%. This feature has been designed to extend your battery's life.
- After charging commences, the battery will charge to 100% capacity and then enter Sleep mode.
- When attached to the battery base, external power passes through the battery circuitry into the printer. The battery does not charge while printing or moving media.
- The battery uses only a very small amount of power during Sleep mode so as to maximize the available charge stored in the battery.

- It takes about two hours to charge a fully-discharged battery.

Using UPS Mode

The printer receives external power from the battery circuitry when it is connect to a battery base and external battery.

1. Press **Battery Control** to wake up the battery and check if it has charge.
If printer power is turned OFF, the battery goes to sleep after 60 seconds.
2. Turn the printer ON and OFF as you normally would.



NOTE: You do not have to turn battery power ON or OFF to operate the printer.

Using the Printer in Battery Mode

When printing with an attached battery base and battery, the printer is powered solely by the battery. Keep the battery charged using this procedure. Your print operation may be interrupted if battery charge is used up and the printer automatically turns off.

1. Press **Battery Control** to wake up the battery and check if the battery has charge. If the printer has not yet been turned on, the battery goes into sleep mode after 60 seconds.
2. Turn printer power ON.
3. Use the printer as you normally would.
4. Check the battery charge status at routine intervals by pressing **Battery Control**.
5. Change the battery or charge it when the last battery charge level indicator flashes.

Send Files to the Printer

You can send graphics, fonts, and programming files to the printer from the Windows OS using Link-OS Profile Manager, Zebra Setup Utilities and the printer driver, ZebraNet Bridge, or Zebra ZDownloader.

Visit zebra.com/support for more information on these utilities.

Printer Fonts

The ZD410 printer supports your language and font requirements in a variety of ways.

Support for your varied font requirements include:

- a variety of internal fonts
- on-board font scaling
- international font sets and character code page support
- Unicode support
- the font download feature compatible with both ZPL and legacy EPL programming languages

The printer's font capabilities are programming-language dependent. The ZPL programming language provides advanced font mapping and scaling technology to support outline fonts (TrueType or OpenType) and Unicode character mapping as well as basic bitmapped fonts and character code pages.

The ZPL programming guide describes and documents the fonts, code pages, character access, listing fonts, and limitations for their respective printer programming languages. See the appropriate printer programming guide for information on text, fonts and character support.

Identify Fonts in Your Printer

Fonts and printer memory reside in shared locations in the printer.

ZPL programming can recognize EPL and ZPL fonts. EPL programming can only recognize EPL fonts. See the respective programming guides for these languages for more information on fonts and printer memory.

Make note of the following for ZPL font management:

- To manage and download fonts for ZPL print operation, use the Zebra Setup utility or ZebraNet Bridge. Go to zebra.com/support.
- To display all fonts loaded onto your printer, send the ^wD ZPL command to the printer. See the ZPL Programming Guide for details. You can identify stored in the various memory areas on your printer by noting their file extensions:
 - Bitmap fonts use the .FNT file extension in ZPL.
 - Scalable fonts use the .TTF, .TTE or .OTF file extensions in ZPL.



NOTE: EPL does not support these fonts.

Localize the Printer with Code Pages

Your printer supports two sets of language, region and character sets for permanent fonts loaded into the printer, one set for each printer programming language, ZPL and EPL. Your printer also supports localization with common international character map code pages.

For ZPL map code page support including support for Unicode fonts, look up the ^CI command in the ZPL programmer's guide which can be downloaded from zebra.com/support.

Asian Fonts and Other Large Font Sets

Ideographic and pictographic Asian language fonts have large character sets with thousands of characters that support single language code pages.

To lend support for the large Asian character sets, the industry adopted a double-byte (67840 maximum) character system instead of the single-byte characters (256 maximum) used by Latin-based language characters to address large font sets.

Unicode was later invented to address multiple languages with a single font set. Unicode fonts support one or more code points (compare these to code page character maps). They are accessed through a standard method which resolves character mapping conflicts.

The ZPL programming language supports Unicode. Both of the printer's programming languages support the large pictographic double-byte character Asian font sets.

The number of fonts that can be downloaded is dependent upon the amount of printer flash memory not already in use and the size of the font(s) to be downloaded to the printer.

Some Unicode fonts such as the Andale font (22 MB) offered by Zebra and the MS Arial Unicode font (23 MB) offered by Microsoft take up considerable space in the printer's storage locations. These large font sets typically support a large number of languages.

Get Asian Fonts

Bitmap Asian font sets are downloaded to the printer either by the integrator or the user.

ZPL Asian fonts are available separately from the printer. EPL Asian Fonts are available to download for free from the Zebra web site at zebra.com/support.

Your printer supports the Asian fonts listed below:

- Simplified and Traditional Chinese
- Japanese — JIS and Shift-JIS mappings
- Korean including Johab
- Thai



NOTE: The SimSun font is pre-loaded in printers sold in the Peoples Republic of China (PRC).

EPL Line Mode – Direct Thermal Printers only

Your Zebra direct thermal printers support Line Mode printing. EPL Line Mode printing is designed to be command compatible with some legacy Zebra printers. The Link-OS four-inch desktop printers continue Zebra's support of Line Mode printing.

Line Mode printing is ideal for basic retail (point of sale or POS), shipping, inventory, workflow control, and general labeling. EPL printers with line mode are versatile. They are capable of printing a wide range of media and barcodes.

Line Mode printing prints only single lines the height of the largest element present in the line of text and data, whether it is a barcode, text, or a logo or simple vertical lines. Line mode has many limitations due to the single line of print. They include no fine element placement, no overlapping elements, and no horizontal (ladder) barcodes.

You can access Line Mode printing as follows:

- Enter Line Mode printing by sending the printer the EPL `OEPL1` command. (See the EPL Programmers Guide (Page Mode) or the EPL Line Mode Programmers Guide. This and the other guides mentioned here are available from zebra.com/support).
- Exit Line Mode printing by sending the printer the `escOEPL2` Line Mode command. See the EPL Line Mode Programmers Guide for details.
- When Line Mode is activated, ZPL and EPL (EPL2) Page Mode programming will be processed as Line Mode programming and data.
- With the default ZPL and EPL (EPL2) Page Mode active, Line Mode programming will be processed as ZPL and/or EPL programming and data.



NOTE: Verify printer programming modes by printing out a Printer Configuration report. See [Printing the Printer Configuration Report \(CANCEL Self Test\)](#) on page 141.

Zebra ZKDU Printer Accessory

The Zebra Keyboard Display Unit (ZKDU) is a small terminal unit that interfaces with the printer to help access to EPL or ZPL label forms stored in the printer.

The ZKDU is strictly a terminal. It does not have the capability to store data or set up parameters.

The ZKDU is used for the following functions:

- list label forms stored in printer.
- retrieve label forms stored in printer.
- input variable data.
- print labels.
- switch between EPL and ZPL to dual-support both printer language format/form types that can be stored and printed in many later model Zebra label printers.

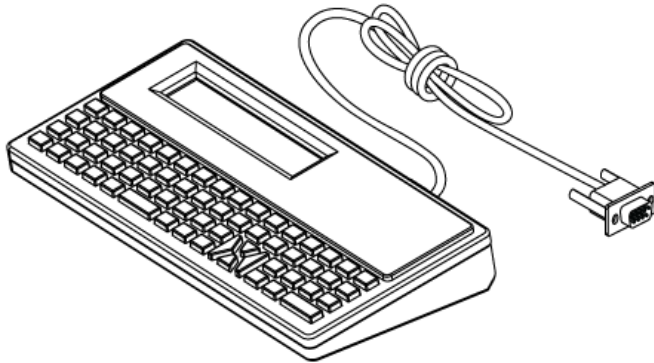

ZBI 2.0 — Zebra Basic Interpreter

Customize and enhance your printer using the ZBI 2.0 programming language. ZBI 2.0 allows Zebra printers to run applications and take input from scales, scanners, and other peripherals without a PC or network connection.

ZBI 2.0 works with the ZPL printer command language so that printers can understand non-ZPL data streams and convert them into labels. That means the Zebra printer can create barcodes and text from input sent to the printer and from non-ZPL label formats, sensors, keyboards, and peripherals. Printers can also be programmed to interact with PC-based database applications to retrieve information to be used on printed labels.

To activate ZBI 2.0 in your printer, order a ZBI 2.0 Key Kit or purchase a ZBI 2.0 key from zebra.com/software.

If you purchased a key, use the ZDownloader utility to apply the key. ZDownloader is available for download from the Zebra website at zebra.com/support.

An intuitive ZBI-Developer programming utility which you can use to create, test, and distribute ZBI 2.0 applications is available for download from the Zebra website at zebra.com/support.

Updating Printer Firmware

The printer's firmware may need to be updated periodically to get new features, improvements, and printer upgrades. Use Zebra Setup Utilities (ZSU) to load new firmware.

Download the latest firmware for your printer from zebra.com/support.

1. Open the ZSU tab in Zebra Setup Utilities.
2. Select your ZD410 printer.

3. Click **Open Printer Tools.**

The Tools window opens.

4. Click the **Action tab.**

5. Load media in the printer. See [Roll Media Sensing and Media Loading](#) on page 48.

6. Click **Send file.**

The lower half of the window will show a path and a filename and a **Browse...** button.

7. Click **Browse and select the latest firmware file you downloaded from the Zebra web site at zebra.com/zd410d-info.**

8. Observe the control panel and wait.

If the firmware version shown differs from the version installed on your printer, the firmware downloads to the printer. The data indicator flashes Green while the firmware is downloading. The printer restarts with all indicators flashing. The Status indicator displays solid Green as the firmware is validated and installed. A Printer Configuration report automatically prints. The firmware update is complete.

Setting the Power Failure Recovery Mode Jumper

If a Printer Connectivity module is installed in your printer, the printer can be configured to restart itself after a power failure.

The Printer Connectivity module have a Power Failure Recovery jumper set to OFF. With the jumper set to ON, the printer will automatically power itself ON when plugged into an active AC power source.



CAUTION—ESD: The discharge of electrostatic energy that accumulates on the surface of the human body or other surfaces can damage or destroy the printhead or electronic components used in this device. You must observe static-safe procedures when working with the printhead or the electronic components.

1. Disconnect the DC power plug and any interface connectors from the back of the printer.

2. Remove the module access door and connectivity module. See [Removing the Printer Connectivity Modules](#) on page 33.

3. Move the AUTO (Power Failure Recovery Mode) jumper from the OFF position to the ON position.

4. Reinstall the connectivity module and module access door. See [Installing the Internal Ethernet \(LAN\) Module](#) on page 32 or [Installing the Serial Port Module](#) on page 31.

5. Reconnect the DC power plug and interface cables to the printer.

Power failure recovery mode is enabled.

USB Host Port and Link-OS Usage

The USB host port allows you to connect USB devices—such as a keyboard, scanner, or USB flash (memory) drive—to the printer. Use the information in this section to understand the operations of the printer's USB host port and Link-OS features and apps.

The USB host port on your printer has multiple uses. Besides serving as a conduit for firmware updates and file transfers, it serves as a port for low-power USB data entry devices (keyboards, scales, scanners, and other devices).

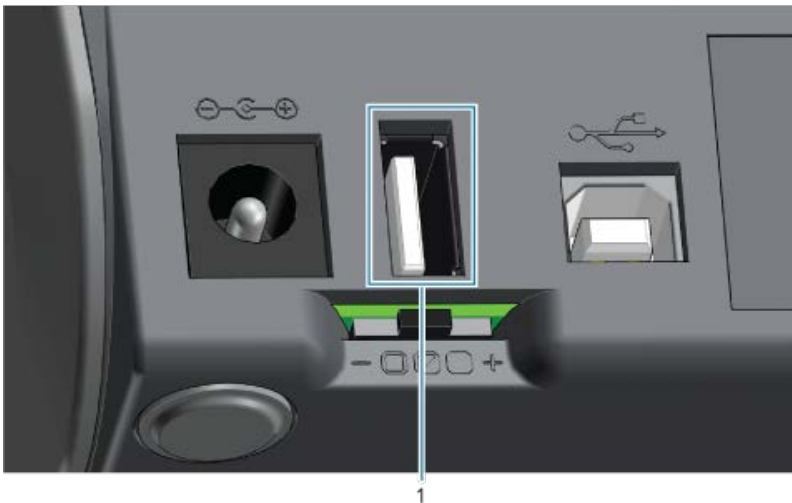

1	USB host port
---	---------------



IMPORTANT: The USB Flash drive must be formatted with the FAT file system.

Filenames may be 1 to 16 long consisting only of alphanumeric characters (A, a, B, b, C, c, . . . , 0, 1, 2, 3, . . .). Use only ASCII characters. Do NOT use Asian characters, Cyrillic characters, or accented characters in filenames.

Some functions may not work properly if underscores are used in a filename. Use periods instead.

Use a USB Host for Printer Firmware Updates

The USB host port allows you to connect a USB flash drive to the printer to perform firmware updates.

Zebra Mirror functions are an example of using the powerful printer management features. Look up the Mirror and Set-Get-Do (SGD) `usb.mirror` commands in the ZPL Programming Guide available from zebra.com/support.



IMPORTANT: Your printer supports USB Flash drives (also known as thumb drives or memory sticks) with a storage capacity of up to 1 Terabyte (TB). It will not recognize drives larger than 1 TB.

Preparing Flash Drive and Updating Firmware

1. On your USB Flash Drive, create the following:
 - a folder called `zebra`
 - and in that folder, create three sub-folders:
 - `appl`
 - `commands`
 - `files`
2. In the `/appl` folder, place a copy of the latest firmware for your printer.
3. Load the printer with media. See [Roll Media Sensing and Media Loading](#) on page 48.
4. Insert the USB Flash drive into the USB host port on your printer.
5. Observe the user interface and wait.

If the firmware version on the USB Flash drive is different than the version installed on the printer, the firmware downloads to the printer. The Data indicator () flashes Green while the firmware is downloading. The printer restarts with all indicators flashing. When the firmware update is complete, the Status indicator displays solid Green. The firmware is validated and installed. A printer Configuration Report automatically prints and the firmware update completes.

6. Remove the USB Flash drive from the printer.

USB Host and Printer Usage Examples

The exercises in this section will teach you how to perform USB mirror (using an alternate firmware update procedure), how to transfer files to and from the printer, and how to provide information for which you are prompted and then print a label using that information.

Items Required for the USB Host Exercises

To perform the exercises in this document, you will need the following:

- USB Flash drive up to 1 Terabyte (TB). The printer will not recognize drives larger than 1 TB.
- USB keyboard.
- Various files referenced below (from files attached inside this PDF file)
- Free Zebra Utilities app for your smart phone (search for Zebra Tech in the Google Play store).

Files for Completing the Exercises

Most of the files you need to complete the exercises in these section are available zebra.com in the form of a .ZIP file located on the Zebra web site here. Download this archive file and extract its contents on your computer.

Where possible, the contents of the files are shown in this section. Contents of files that include coded content—which cannot be viewed either as text or as an image—are not shown.

File 1: ZEBRA.BMP



File 2: SAMPLELABEL.TXT

```
^XA
^FO100,75^XGE:zebra.bmp^FS
^FO100,475^A0N,50,50^FDMirror from USB Completed^FS
^XZ
```

This simple label format prints the Zebra logo and a line of text at the end of the mirroring exercise.

File 3: LOGO.ZPL

Uses the Zebra logo bitmap file.

File 4: USBSTOREDFILE.ZPL

```
CT~~CD,~CC^~CT~
^XA~TA012~JSN^LT0^LH0,0^JMA^PR4,4~SD15^LRN^CI0^XZ
~DG000.GRF,07680,024,,[image data]
^XA
^LS0
^SL0
^BY3,3,91^FT35,250^BCN,,Y,N^FC%,{,##^FD%d/%m/%Y^FS
^FT608,325^XG000.GRF,1,1^FS
^FT26,75^A0N,28,28^FH\^FDThis label was printed from a format stored^FS
^FT26,125^A0N,28,28^FH\^FDOn a USB Flash Memory drive. ^FS
^BY3,3,90^FT33,425^BCN,,Y,N
^FD>:Zebra Technologies^FS
^PQ1,0,1,Y^XZ
^XA^ID000.GRF^FS^XZ
```

This label format prints an image and text. This file will be stored on the USB memory device at the root level so that it can be printed.

File 5: VLS_BONKGRF.ZPL

File 6: VLS_EIFFEL.ZPL**File 7: KEYBOARDINPUT.ZPL**

```

^XA
^CI28
^BY2,3,91^FT38,184^BCN,,Y,N^FC%,{,#{^FD%d/%m/%Y^FS
^FO385,75^XGE:zebra.bmp^FS
^FT40,70^A0N,28,28^FH\^FDThis label was printed using a keyboard input.
^FS
^FT35,260^A0N,28,28^FH\^FDThis label was printed by:^FS
^FT33,319^A0N,28,28^FN1"Enter Name"^FS
^XZ

```

This label format, used for the USB keyboard input exercise, does the following:

- Creates a barcode with the current date, based on your Real-Time Clock (RTC) setting. (RTC may not be present in the printer version you purchased).
- Prints the Zebra logo graphic.
- Prints fixed text.
- Prints text entered with the keyboard by a user.

File 8: SMARTDEVINPUT.ZPL

```

^XA
^CI28
^BY2,3,91^FT38,184^BCN,,Y,N^FC%,{,#{^FD%d/%m/%Y^FS
^FO385,75^XGE:zebra.bmp^FS
^FT40,70^A0N,28,28^FH\^FDThis label was printed using a smart device input.
^FS
^FT35,260^A0N,28,28^FH\^FDThis label was printed by:^FS
^FT33,319^A0N,28,28^FN1"Enter Name"^FS^XZ

```

The same label format as the previous label, only with different text printing. This format is used for the smart device input exercise.

Exercise 1: Copying Files to a USB Flash Drive and Performing USB Mirror

1. On your USB flash drive, create the following:
 - a folder called `zebra`
 - in that folder, three sub folders:
 - `appl`
 - `commands`
 - `files`

2. In the `/appl` folder, place a copy of the latest firmware for your printer.



NOTE: Some functions may not work properly if there are underscores in a file name. Use periods instead.

3. In the `/files` folder, place the following file: `ZEBRA.BMP`
4. In the `/commands` folder, place the following files: `SAMPLELABEL.TXT` and `LOGO.ZPL`.
5. Insert the USB flash drive into a USB host port on the front of your printer.
6. Observe the user interface and wait. The following should happen:
 - If the firmware on the USB flash drive is different than what is on the printer, the firmware downloads to the printer. The printer then restarts and prints a printer configuration label. (If there is no firmware on the USB flash drive or if the firmware version is the same, the printer skips this action.)
 - The printer downloads the files in the `/files` folder and briefly shows the names of the files that are downloading on the display.
 - The printer executes any files in the `/commands` folder.
 - The printer restarts and then displays the message `MIRROR PROCESSING FINISHED`.
7. Remove the USB flash drive from the printer.

Exercise 1: Advanced User Information

See the ZPL Programming Guide for more information about these commands.

Enable/disable mirroring:

```
! U1 setvar "usb.mirror.enable" "value" – Values: "on" or "off"
```

-Enable/disable automatic mirroring that occurs when a USB Flash drive is inserted into the USB host port:

```
! U1 setvar "usb.mirror.auto" "value" – Values: "on" or "off"
```

Mirror operation retry number — Specify the number of times that the mirror operation will be repeated if it fails:

```
! U1 setvar "usb.mirror.error_retry" "value" – Values: 0 to 65535
```

Change file path from USB — Reprogram the file location the printer searches to retrieve files from the USB memory during mirror operations.

```
! U1 setvar "usb.mirror.appl_path" "new_path" – Default: "zebra/appl"
```

Change file path to USB — Reprogram the file location the printer places files into USB memory during mirror operations.

```
! U1 setvar "usb.mirror.path" "path" – Default: "zebra"
```

Enable/disable the USB host port

```
! U1 setvar "usb.host.lock_out" "value" – Values: "on" or "off"
```

Use the USB Host Port and the NFC Capabilities

The Zebra Print Touch™ feature allows you to touch an Android-based, Near Field Communication (NFC)-enabled device such as a smart phone or tablet to the printer's Print Touch logo to pair the device to the printer. This capability allows you to use your device to provide information for which you are prompted and then print a label using that information.

This feature is not supported by all printer configurations. Only printers with the Print Touch logo have this feature.



IMPORTANT: Some mobile devices may not support NFC communication with the printer until you configure the required NFC settings in your device. If you encounter difficulties, consult your service provider or your smart device manufacturer for more information.



Exercise 2: Entering Data for a Stored File with a Smart Device and Printing a Label



NOTE: The steps in this exercise may vary somewhat based on your smart device, on your service provider, or on whether you already have the free Zebra Utilities app installed on your smart device.

Refer to the Zebra Bluetooth User Guide for specific instructions for configuring your printer to use a Bluetooth interface. A copy of this manual is available at zebra.com/support.

1. If you do not have the Zebra Utilities app installed on your device, go to the app store for your device, search for the Zebra Utilities app, and install it.

2. Pair your smart device with the printer by holding the smart device next to the **Zebra Print Touch** icon on the printer.
 - a) If necessary, access the Bluetooth information about your printer using your smart device. For instructions, refer to the manufacturer's documentation for your device.
 - b) If necessary, select the Zebra printer's serial number to pair it with the device.
 - c) After your smart device has been detected by the printer, the printer may prompt you to accept or reject the pairing. Some smart devices will pair with the printer without this prompt.

The printer and your device are paired.
3. Open Zebra Utilities on the device or computer you are using to manage your printer.

The Zebra Utilities main menu displays.



4. Perform these steps if you have an Apple device:
 - a) Tap **Settings** () in the lower right corner.
 - b) Change the setting for **Get Labels From Printer** to **ON**.
 - c) Tap **Done**.
 - d) Tap **Files**.

The smart device gets data from the printer and displays it. This retrieval process may take a minute or more to complete.
5. Scroll through the formats shown and select `E : SMARTDEVINPUT . ZPL`.

Based on the `^FN` field in the label format, the smart device prompts you for your name.
6. Enter your name at the prompt.

7. If desired, change the quantity of labels to print.
8. Tap **Print** to print the label.

Maintenance

This section provides routine cleaning and maintenance procedures.

Clean the Printer

Your printer requires periodic maintenance to keep it good working order and printing quality labels, receipts, tags, etc.

Recommended Cleaning Supplies

The following printer cleaning supplies are recommended for use with your printer:

- Printhead cleaning pens—for simple operator printhead cleaning
- 99% pure isopropyl alcohol—use a labeled dispenser
- Fiber-free cleaning swabs—for media path, guides, and sensors
- Cleaning Wipes—for media path and interior (ex., Kimberly-Clark Kimwipes)
- Can of compressed air—to clean inside parts that are too sharp or sensitive to be cleaned using other methods



IMPORTANT: Never re-moisten cleaning materials used to clean the printer.



IMPORTANT: The cutter mechanism does not require maintenance cleaning. DO NOT clean the blade or mechanism. The blade has a special coating to resist adhesives and wear.



IMPORTANT: Using too much alcohol can result in contamination of the electronic components requiring a much longer drying time before the printer will function properly.



IMPORTANT: Do NOT Use an air compressor in place of the can of compressed air. Air compressors have micro-contaminants and particles that get into the air system and damage your printer.



CAUTION—EYE INJURY: Use eye protection to protect your eyes from flying particles and objects when using compressed air to clean the inside of your printer.



Get Zebra Supplies and Accessories for Cleaning Your Printer

We recommend that you purchase Zebra supplies and accessories. These are specifically designed to work with your Zebra printer.

For a list of available cleaning supplies, go to zebra.com/supplies.

Recommended Cleaning Schedule

Component / Area	Recommendations
Printhead	Clean the printhead after printing every five rolls of media. See Cleaning the Printhead on page 121.
Standard platen (drive) roller	As needed to improve print quality. Platen rollers can slip causing print image distortion and in worst case scenarios not move the media (labels, receipts, tags, etc.) See Cleaning and Replacing the Platen (Drive Roller) on page 126. Standard platen rollers come in two colors, black (203 dpi) and gray (300 dpi).
Media path	Clean thoroughly as needed with fiber-free cleaning swabs and cloths moistened with 99% isopropyl alcohol. Let alcohol evaporate completely. See Cleaning the Media Path on page 122.
Interior	Clean as needed using a soft cloth, brush or compressed air to wipe or blow dust and particles out of the printer. Use 99% isopropyl alcohol and a fiber-free cleaning cloth to dissolve contaminants like oils and grime.
Exterior	Clean as needed using a soft cloth, brush, or compressed air to wipe or blow dust and particles out of the printer. The exterior of the printer can be cleaned using plain soap and water solutions to moisten the cloth. Only use the minimum amount of cleaning solution to avoid getting solution in the printer or other areas. Do NOT clean connectors or interior of the printer with this method. The latest healthcare printer models now include ultraviolet (UV) and disinfectant-ready plastics for hospital and other similar environments. The printer user interface controls are sealed so they can be cleaned with the rest of the printer's exterior. See the 'Guide To Disinfecting and Cleaning Zebra Healthcare Printers on the Zebra website at zebra.com/support for the latest information on tested and approved cleaning materials and cleaning methods.
Label dispenser option	Clean as needed to improve label dispenser operations. For details on operating the dispenser, see Using the Label Dispenser Option on page 100.

Component / Area	Recommendations
Cutter option	<p>The cutter is not a user-serviceable component. Do NOT clean inside the cutter opening or blade mechanism. However, you may use the exterior cleaning procedure to clean the cutter bezel (housing). For cleaning and maintenance of this option, call a service technician.</p> <p> CUT WARNING: There are no operator serviceable parts in the cutter unit. Never remove the cutter cover (bezel). Never attempt to insert objects or fingers in to the cutter mechanism.</p> <p> IMPORTANT: The blade has a special coating to resist adhesives and wear. Cleaning it may ruin the blade.</p> <p> IMPORTANT: Use the recommended cleaning supplies listed in Recommended Cleaning Supplies on page 119. Using unapproved tools, cotton swabs, solvents (including alcohol), etc. may damage or shorten the cutter’s usable life or cause the cutter to bind.</p>

Cleaning the Printhead

For optimal print operations, clean the printhead each time you load a new roll of media.

Always use a new cleaning pen on the printhead. Old, used cleaning pens carry contaminants from previous use that may damage the printhead.



CAUTION: The printhead becomes hot while printing. To protect from damaging the printhead and risk of personal injury, avoid touching the printhead. Only use the cleaning pen to perform printhead maintenance.



CAUTION—ESD: Observe static-safe procedures when working with the printhead or the electronic components under the top cover. The discharge of electrostatic energy that accumulates on the surface of the human body or other surfaces can damage or destroy the printhead and other electronic components used in this device.

1. Rub the cleaning pen across the dark area of the printhead. Clean from the middle to the outside.
This will move adhesive transferred from the edges of media to the outside of media path.

2. Wait one minute before you close the printer to allow the wet areas to dry fully.

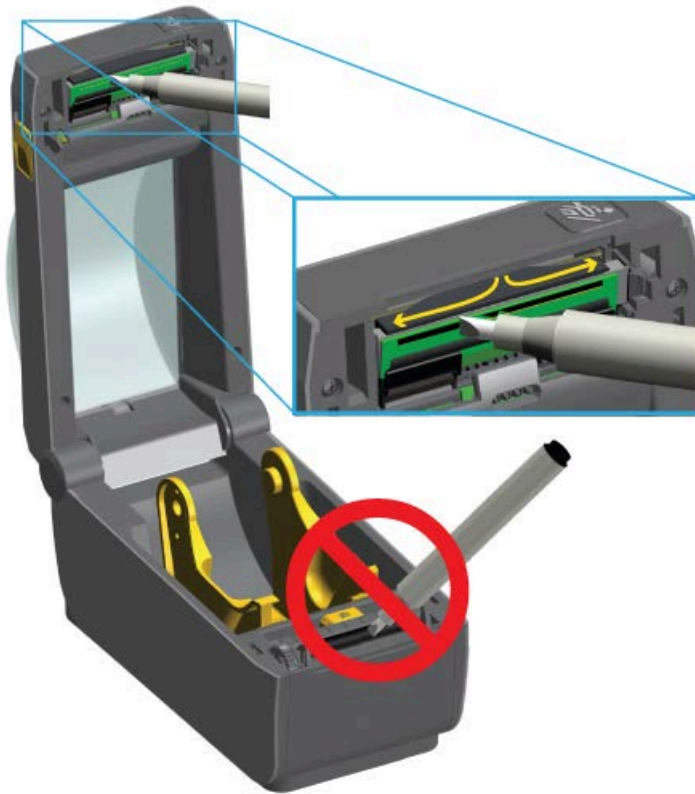

Cleaning the Media Path

Use a cleaning swab and or a lint-free cloth to remove debris, dust or crust that has built-up on the holders, guides, and the media path surfaces.

Lightly moisten the swab or cloth with 99% solution medical-grade alcohol. For hard to clean areas, use extra alcohol on a cleaning swab to soak the debris to break up any adhesive that may have accumulated on surfaces in the media compartment.



IMPORTANT: Do NOT clean the printhead, movable sensor, or platen as part of this process.

1. Wipe the inside areas of the media compartment.
2. Wipe the inside surfaces of the roll holders and the underside of the media guides with a swab.
3. Wipe the movable sensor slide channel (but not the sensor). Move the sensor gently as needed to get to all areas.

4. Wait one minute before closing the printer to allow time for all cleaned areas to dry thoroughly.



1	Media roll holders and guides
---	-------------------------------



NOTE: Use a clean swab for each cleaning. Discard all used cleaning swabs.

Options for Cleaning the Cutter and Label Dispenser

If either the Cutter option or the Label Dispenser option is installed on your printer, be sure to clean them as well following the procedures in [Cleaning the Cutter](#) on page 124 and [Cleaning the Label Dispenser](#) on page 124.

Cleaning the Cutter

While the media path surfaces can be cleaned, the internal cutter blades and mechanism are NOT a user-cleanable component. You will only need to wipe the areas around the cutter,

1. Wipe the ridges and the plastic surfaces of the media entry (inside) and exit slot (outside) of the cutter, the areas outlined in blue in these images.
2. Repeat as necessary to remove any adhesive or contaminate residue after the cleaned areas have dried.

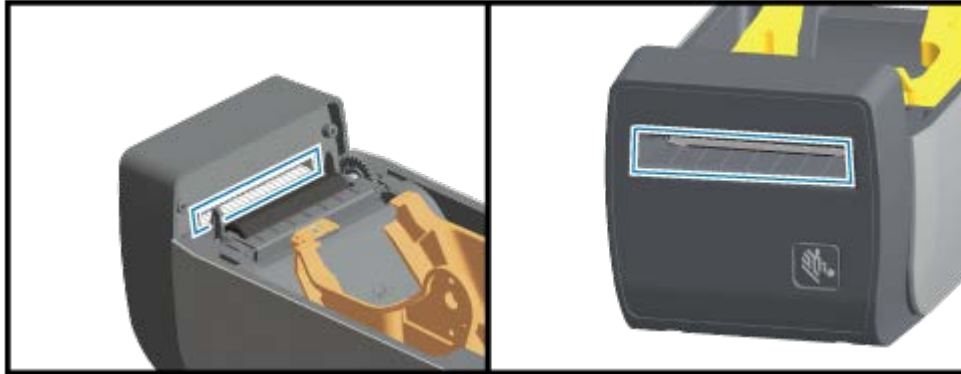

Cleaning the Label Dispenser

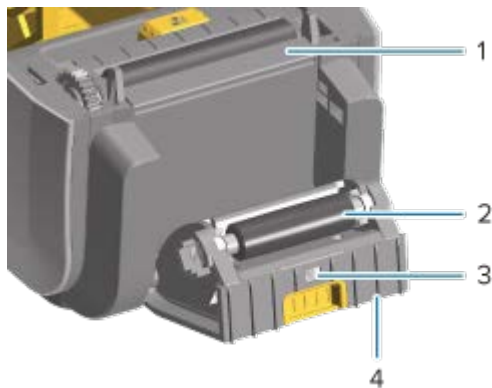

1	Peel bar
2	Pinch roller
3	Label-taken sensor
4	Ridges

1. Open the door and clean the peel bar (1), the inner surfaces, and the ridges on the door (4).
2. Wipe the roller (2) while rotating it. Discard the swab or cloth and clean again to remove any residue.
3. Clean any streaks and residue on the label-taken sensor (3) window.

Cleaning the Sensors

The sensors must be cleaned periodically to remove any accumulated dust.



IMPORTANT: Do NOT use an air compressor to remove dust. Compressors add moisture, fine grit, and lubricant which can contaminate your printer.



1	Upper array sensor (web/gap)
2	Movable sensor (black mark and lower web/gap)

1. If necessary, use a dry cleaning swab to gently brush away dust from the sensor or use a can of compressed air.
2. If adhesives or other contaminants remain, use an alcohol moistened swab to break any of this build-up.
3. Use a dry swab to gently remove any residue that may be left from the first cleaning.

- Repeat steps 1 and 2 as required until all residue and streaks are removed from the sensor.

Cleaning and Replacing the Platen (Drive Roller)

The platen is the print surface and drive roller for your media. Contaminants on the platen roller can damage the printhead or cause the media to slip or stick when printing. Adhesive, dirt, general dust, oils and other contaminants should be cleaned immediately off the platen.

Clean the platen (and media path) whenever the printer has significantly poorer performance, print quality or media handling when compared to normal printing performance. If sticking or jamming of media continues even after cleaning the platen, you will need to replace the platen.

The platen can be cleaned with a fiber-free swab (such as a Texpad swab) or a lint-free, clean, damp cloth very lightly moistened with medical grade alcohol (99% pure or better).

- Open the cover (and dispenser door if the dispenser is installed).
- Remove media from the platen area.
- Pull the platen-bearing latch release tabs on the right and left sides towards the front of the printer and rotate them up.

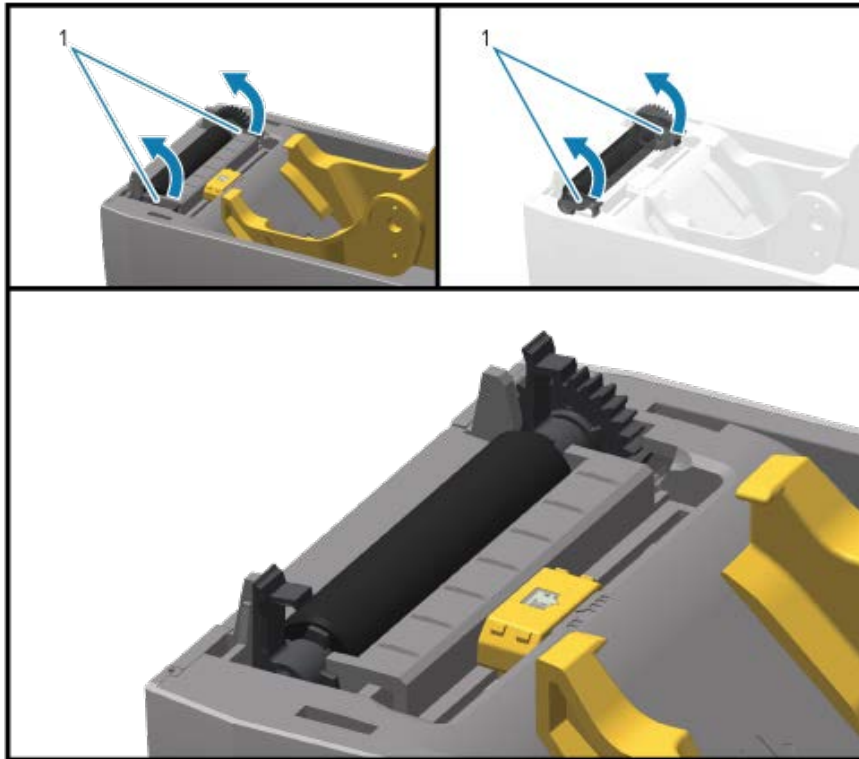

1	Platen bearings
---	-----------------

4. Lift the platen out of the printer's bottom frame.

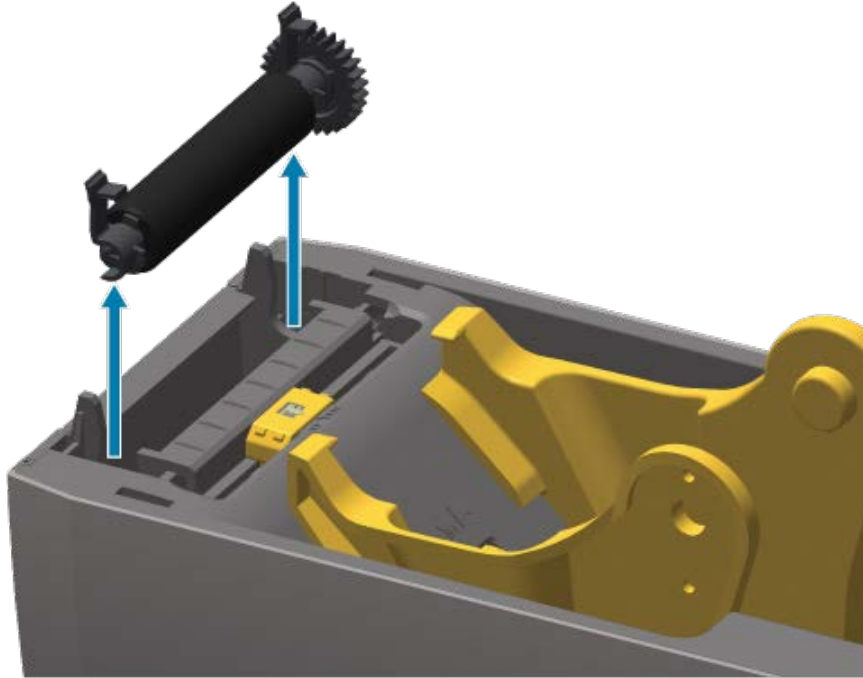

5. Slide the gear and the two bearings off the shaft of the platen roller.

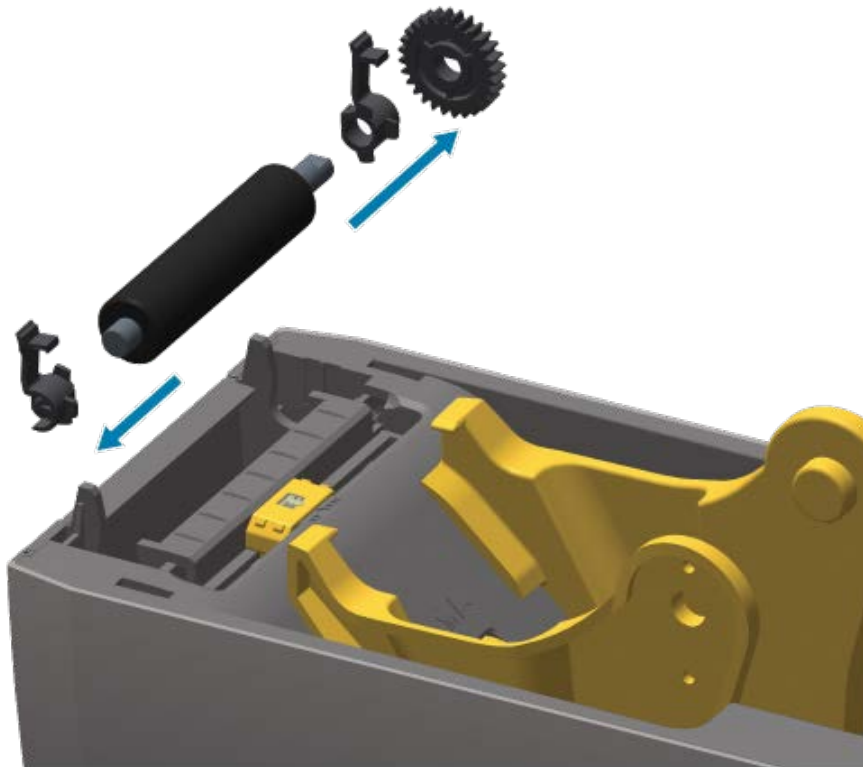

6. Clean the platen with the alcohol-moistened swab. Clean from the center out. Repeat this process until all of the roller surface has been cleaned. If there has been heavy adhesive build-up or a label jam, repeat with a new swab to remove residual contaminants. Adhesives and oils, for example, may be thinned by the initial cleaning but not completely removed.
7. Discard the cleaning swabs after use. Reusing used cleaning swabs for cleaning may contaminate the platen surface.
8. Make sure the bearings and drive gear are on the shaft of the platen roller.

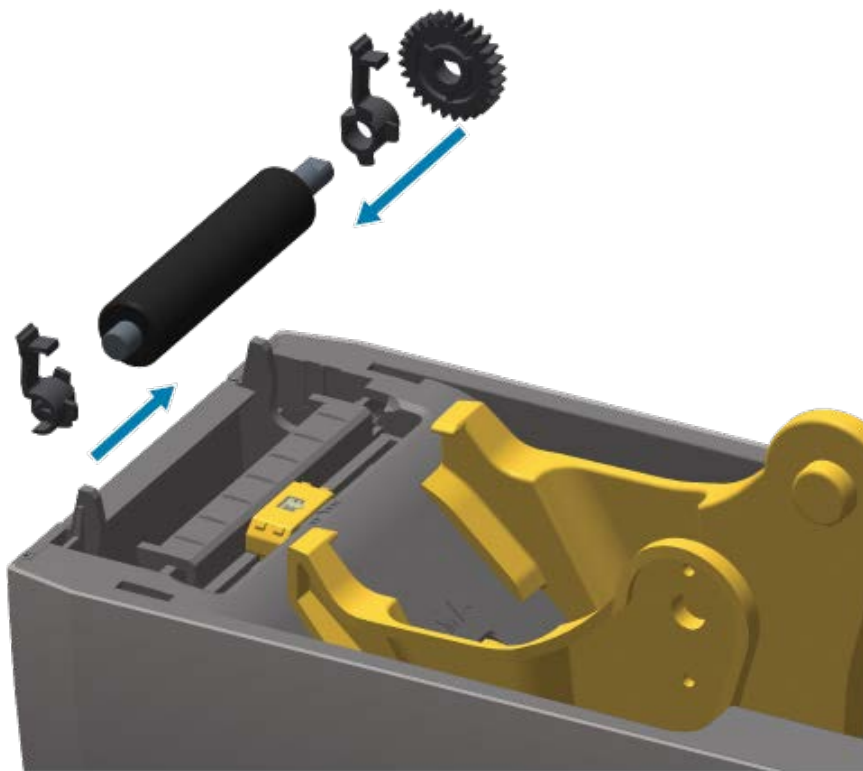

9. Align the platen with the gear to the left and lower it into the printer's bottom frame.
10. Rotate the platen-bearing latch release tabs down on the right and left sides towards the rear of the printer and snap them into place.

Allow the printer to dry for one minute before closing the dispenser door and the media cover and loading new media.

Other Printer Maintenance

There are no user level maintenance procedures beyond those detailed in this section. See [Troubleshooting](#) on page 133 for more information on diagnosing printer and print problems.

Real-Time Clock (RTC) Battery

Real Time Clock (RTC) is available with printers on which networking options are factory-installed and which are paired using the Zebra Print Touch feature. See [Zebra Print Touch](#) on page 27.

The RTC battery is rated to provide approximately 10 years of service. It is not user-replaceable. See a Zebra authorized service technician to replace the RTC battery. For details on your printer and printer component warranties, go to the Zebra website at zebra.com/warranty.



CAUTION: The printer's RTC battery is a three-volt battery. If the printer consistently provides a delayed time stamp which usually indicates a flat or low RTC battery condition. Battery replacement must be performed by a qualified service technician. Only a Zebra-approved replacement battery must be used as a replacement.



CAUTION: Do NOT short-circuit the battery. Doing so may generate heat, cause a fire, or burst the battery. By that same token, do NOT heat the battery, disassemble it, or dispose of it in a fire.



IMPORTANT: Recycle batteries according to local your guidelines and regulations. Wrap the battery during disposal or storage to avoid a short circuit.

No Replaceable Fuses

There are no replaceable fuses in this Zebra printer or in its power supplies.

Replace the Printhead

Before you start, review the procedures to remove the existing printhead and install a new one.



CAUTION—ESD: Prepare your work area to protect against static discharge. The area must be static-safe. Use a properly-grounded, conductive-cushioned mat to hold the printer. Be sure to wear a conductive wrist strap.



CAUTION: Unplug the printer from the power supply and allow the printer to cool to prevent injuries or damage to printer circuitry.

Before you begin, open the printer by pulling the release latches forward, lift the top cover, and follow the steps in [Removing the Printhead](#) on page 129 and [Replacing the Printhead](#) on page 131.

Removing the Printhead

1. Turn printer power OFF.
2. If you have not done so already, open the printer.

3. Pull the printhead release latch on the right side of the printhead towards the outside of the printer to release the printhead.



4. Swing the loose right side of the printhead out of the printer. Pull it to the right a little to get the left side of the printhead clear. Pull the printhead free to gain access to its attached cables.

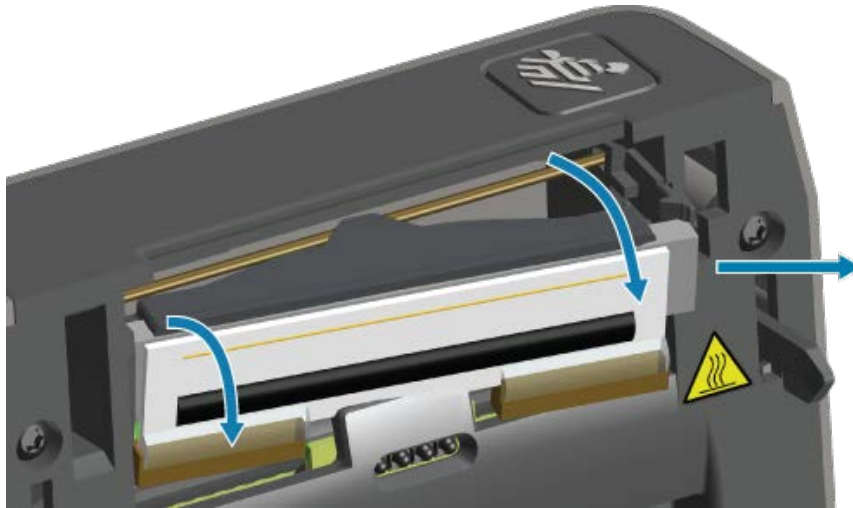

- Gently but firmly pull the two printhead cable bundle connectors off the printhead.

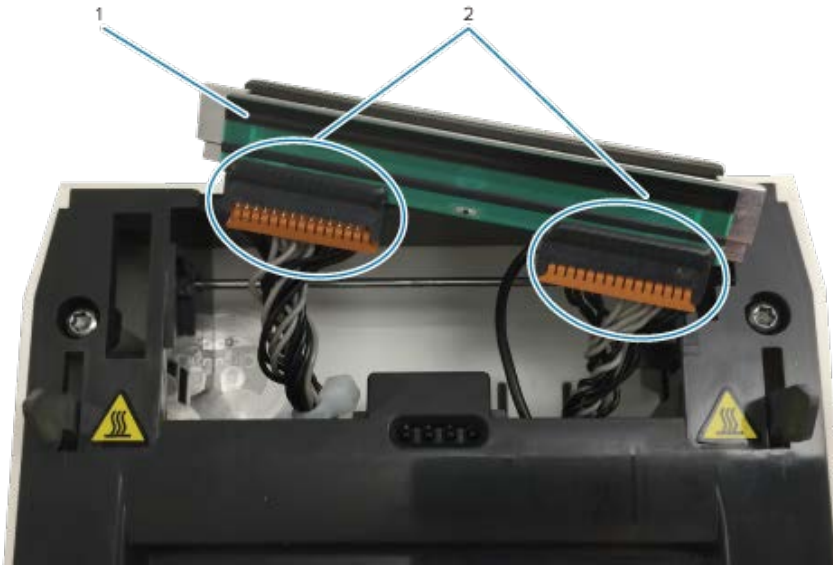

1	Printhead
2	Connectors

- Gently but firmly pull the single black ground wire off the back of the printhead to complete this procedure.

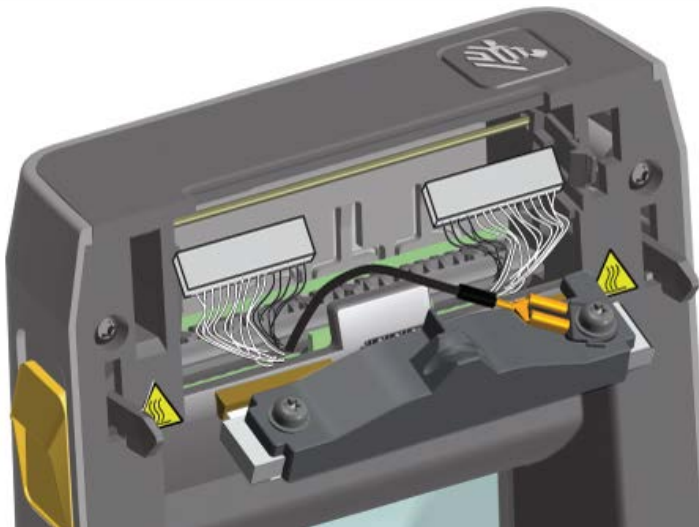

Replacing the Printhead

- Push the right side printhead cable connector into the printhead.



NOTE: The connector is keyed to only insert one way.

2. Connect the single black ground wire spade lug connector onto the spade lug attached to the back of the printhead.
3. Push the left side printhead cable connector onto the printhead.
4. Check that the ground wire and wire bundles are still connected to the printhead.
5. Insert the left side of the printhead assembly into the recessed area.

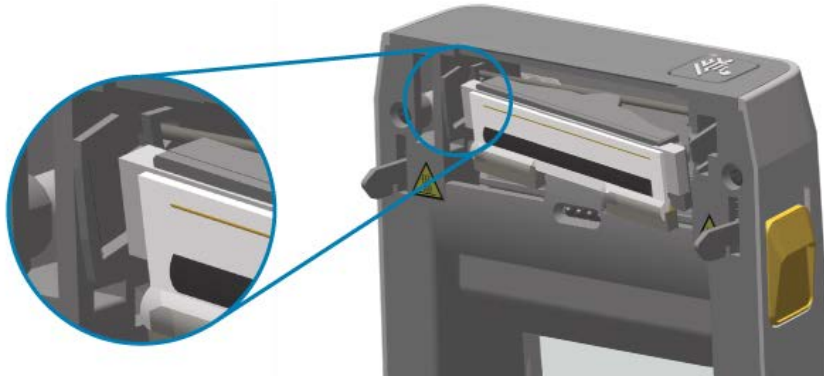

6. Push the right side of the printhead into the printer until the latch locks the right side of the printhead into the printer.

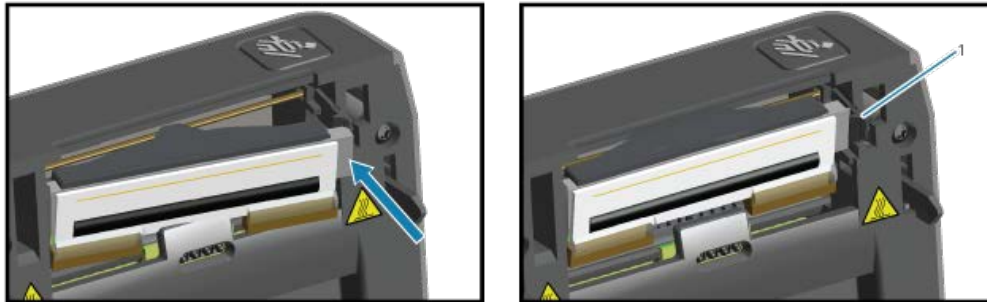







1	Locked
---	--------







7. Verify that the printhead moves freely into the printer when pressure is applied and remains locked when pressure is released.
8. Clean the printhead using a new cleaning pen to wipe body oils (fingerprints) and debris off the printhead. Clean from the center of the printhead to the outside. See [Cleaning the Printhead](#) on page 121.
9. Reload media.
10. Turn printer power ON and print a status report to ensure proper function. See [Testing Printing with the Configuration Report](#) on page 59.



Troubleshooting

This section provides troubleshooting procedures and information.

Resolve Alerts and Errors

Alert	Possible Cause(s) and Remedies
<p>Printhead Open</p> <p>The printer has detected that the printhead (COVER) is not closed after a print command has been issued or after a FEED button () press</p> <p></p>	<p>The cover is open or has not been closed properly. Close the cover/ printhead. Push down on the front top corners of the printer's cover until you hear and feel the cover latches snap in place.</p> <p>The printer's Head-Open switch needs service. Call a service technician for assistance.</p>
<p>Media Out</p> <p>The printer cannot detect media in the print path after a print command has been issued or after a FEED button () press.</p> <p></p>	<p>There is no media (roll) in the printer. Load media and close the printer cover. You may need to press FEED () once or press PAUSE to resume a print operation that was in progress before the printer ran out of media. See Roll Media Sensing and Media Loading on page 48.</p> <p>A label is missing between two labels at the end of the loaded roll. Roll manufacturers use this method to identify the end of a roll. See Detect a Media Out Condition on page 95. Replace the empty media roll and continue printing.</p> <p> NOTE: To avoid losing a print job that is in progress, do NOT switch printer power OFF to load the media. See Detect a Media Out Condition on page 95.</p> <p>The media sensor is misaligned. Check the position of the media sensor. See Movable Sensor Adjustment on page 54.</p> <p> NOTE: You may have to calibrate the printer for the newly-loaded media after you adjust the sensor location. See Running a SmartCal Media Calibration on page 58.</p>

Alert	Possible Cause(s) and Remedies
	<p>The printer is set for non-continuous (labels or black mark) media, but continuous media is loaded. Check that the media sensor is positioned in the center default location. See Movable Sensor Adjustment on page 54.</p> <p>The printer may need to be calibrated for the media after you adjust the sensor location. See Running a SmartCal Media Calibration on page 58.</p> <p>The media sensor is dirty. Clean the upper web/gap sensor array and the lower movable media sensors. See Cleaning the Sensors on page 125. Reload media, adjust the movable media sensor's position for your media, and recalibrate the printer for the media. See Roll Media Sensing and Media Loading on page 48 and Running a SmartCal Media Calibration on page 58.</p> <p>Media sensing is not working as it should for printing, possibly due to data corruption of memory or faulty components. Reload the printer's firmware. See Updating Printer Firmware on page 109. If this does not fix this issue, call a service technician.</p>
<p>Cut Error</p> <p>The cutter blade is bound and is not moving properly.</p> 	<p>Media, adhesive, or an foreign object has stopped the cutter blade from operating. Turn printer power OFF by holding POWER () down for five seconds. Wait for the printer to shutdown completely., then turn printer power ON. If the printer does not recover from this error, call a service technician for assistance.</p> <p> CUT WARNING: There are no operator serviceable parts in the cutter unit. Never remove the cutter cover (bezel). Never attempt to insert objects or fingers in to the cutter mechanism.</p> <p> NOTE: Using unapproved tools, cotton swabs, solvents (including alcohol), etc. may damage or shorten the cutter's usable life or cause the cutter to jam.</p>
<p>The printhead is over temperature and paused to allow the printhead to cool.</p> 	<p>The printer is printing a large batch job, typically with large amounts of print. The print operation will resume after the printhead has cooled.</p> <p>The ambient temperature at the printer's location exceeds the specified operating range. Ambient temperatures in the printer can at times rise if it is in a location that receives direct sunlight. Move the printer to a different location, or cool the ambient temperature in the location where the printer is operating.</p>
<p>The printhead is below operating temperature for proper printing.</p> 	<p>The printhead has had a critical temperature or power failure.</p> <p>Turn printer power OFF by holding POWER () down for five seconds. Wait for the printer to shutdown completely and turn printer power ON. If the printer does not recover from this error, call a service technician. The printhead is not a operator-serviceable item.</p>

Alert	Possible Cause(s) and Remedies
<p>The printhead is below operating temperature for proper printing.</p> 	<p>The ambient temperature at the printer's location is below the specified operating range. Turn printer power OFF, then move the printer to a warmer location and wait for it to warm naturally. Moisture may condense in and on the printer if the temperature changes too quickly.</p>
	<p>The printhead thermistor has failed. Turn printer power OFF by holding POWER () down for five seconds. Wait for the printer to shutdown completely and turn printer power ON. If the printer does not recover from this error, call a service technician.</p>
<p>Cannot store data in the printer in the specified memory location.</p> <p>There are four types of storage memory: graphic, format, bitmap, and font.</p> 	<p>There is not enough memory to perform the function specified on the second line of the error message.</p> <ul style="list-style-type: none"> Free up some of the printer's memory by adjusting the label format or printer parameters to make the print area smaller. Remove unused graphics, fonts, or formats. Ensure that the data is not directed to a device that is not installed or is unavailable.

Resolve Print Issues



Use this information to identify issues with printing or print quality, the possible causes, and the recommended solutions.

Issue	Possible Cause(s) and Remedies
<p>The printed image does not look right.</p>	<p>The printer may be set at an incorrect darkness level and/or print speed. Perform the Print Quality test (FEED self test) to determine the ideal darkness and speed settings for your application. Be sure NOT to set print speeds above the manufacturer's maximum rated speed for your print media. See Resetting Non-Network Printer Configuration Settings to their Factory Defaults on page 147 and Adjust the Print Quality on page 96.</p>
	<p>The printhead may be dirty. Clean the printhead. See Cleaning the Printhead on page 121.</p>
	<p>The platen roller is dirty or damaged. Clean or replace the platen. See Cleaning and Replacing the Platen (Drive Roller) on page 126.</p>
	<p>The printhead has worn out or is damaged. Replace the printhead. See Replace the Printhead on page 129.</p>
	<p>The wrong power supply may be in use. Verify you are using the power supply that came with this printer.</p>
<p>No print on the label.</p>	<p>The media may not be direct thermal media (and is thermal media, made for thermal transfer printers). Load the right media for your printer type. See Performing a Media Scratch Test on page 164 to determine the media type.</p>

Issue	Possible Cause(s) and Remedies
	Media has been loaded incorrectly. The media printable surface must face up towards the printhead. See Get Ready to Print on page 47 and Roll Media Sensing and Media Loading on page 48.
Labels are distorted in size, or the print area start position varies, or the printed image skips between labels (faulty registration).	Media has been loaded incorrectly or the movable media sensor is not set properly. Verify that the sensor is set and positioned correctly for your media type and sensing location. See Roll Media Sensing and Media Loading on page 48, Set Media Sensing by Media Type on page 49, and Movable Sensor Adjustment on page 54.
	The media sensors are not calibrated for your media length, physical properties, or sensing type (gap/notch, continuous, or mark). See Running a SmartCal Media Calibration on page 58. If it still skips labels try Manually Calibrating Media on page 151.
	The platen (drive) roller is slipping or damaged. Clean or replace the platen. See Cleaning and Replacing the Platen (Drive Roller) on page 126.
	The printer may have communication issues with cables or communication settings. See Resolve Communication Issues on page 136.

Resolve Communication Issues

This section identifies problems with communications, the possible causes, and the recommended solutions.

Issue	Possible Cause(s) and Remedies
<p>USB printer fails to install after connecting printer, before installing the printer driver.</p>	<p>Whereas the printer is connected to the Windows computer via USB, it is not properly recognized by the system. A Windows-assigned printer that is incorrectly assigned cannot print a Windows test print from the selected USB-attached computer.</p> <p>The USB cable was attached before the correct printer drivers were pre-installed. Windows installed the Windows generic printer driver.</p> <p>To fix the problem:</p> <ol style="list-style-type: none"> 1. Disconnect the printer USB cable from the Windows computer. 2. Use the Windows Search bar to search for and open Control Panel > Devices and Printers. The Zebra printer shows up under the title 'Unspecified'. Zebra printers display ZTC as a prefix to identify them easily. <div style="text-align: center;">  <p style="font-size: small; margin: 0;"> ▼ Unspecified (1) ZTC Z -203dpi ZPL </p> </div> <ol style="list-style-type: none"> 3. Click on any Zebra printers icons displayed under 'Unspecified' and delete them. 4. If you have not previously loaded the Windows Printer Driver v8, load it now. See Installing the Drivers on page 66 to help you add the correct drivers to the system. 5. Plug the printer's USB cable into the Windows computer. <p>The Zebra printer should now be added to the Printers section of the Devices and Printers window.</p>
<p>Label job sent to printer, but data is not transferred to the printer.</p> <p>A label format was sent to the printer but was not recognized.</p> <p>The Data indicator () does not flash.</p>	<p>The communication parameters are incorrect. Check the printer driver or software communications settings (if applicable).</p> <p>If you are using a serial port connection, check the printer's handshake protocol and serial port settings. The setting used must match the settings of the host computer. See Serial Interface on page 60 for information on the printer's default serial port settings.</p> <p>The serial cable you are trying to use may not be a standard DTE or DCE type cable, is damaged, or is too long in comparison to the RS-232 serial port specifications. See Serial Port Interface on page 157 for details.</p>
<p>Label job sent. Printer skips labels or prints faulty content.</p> <p>A label format was sent to the printer. Several labels print, then the printer skips, misplaces, misses, or distorts the image on the label.</p>	<p>The serial communication settings are incorrect. Check the printer driver or software communications settings (if applicable). Ensure that the Flow Control settings and other serial port handshake settings match that of the host computer.</p>

Issue	Possible Cause(s) and Remedies
<p>Label job sent, data transfers, but there are printing issues.</p> <p>A label format was sent to the printer. Several labels print, then the printer skips, misplaces, misses, or distorts the image on the label.</p>	<p>The serial communication settings are incorrect. Check the printer driver or software communications settings (if applicable). Make sure that the Flow Control settings and other serial port handshake settings match what the host system requires.</p>

Resolve Miscellaneous Issues

This section identifies miscellaneous issues with the printer, the possible causes, and the recommended solutions for each issue.

Issue	Possible Cause(s) and Remedies
Settings are lost or ignored.	<p>Some parameters are set incorrectly. Printer settings may have been changed but not saved (ex., the ^JZ ZPL command was not used to save the configuration before turning printer power OFF.) Cycle printer power OFF and then back ON to verify settings have been saved.</p>
	<p>The label format/form commands or commands sent directly to the printer have syntax errors or have been used incorrectly.</p> <ul style="list-style-type: none"> • A firmware command turned off the ability to change the parameter, or • A firmware command changed the parameter back to default setting. <p>See the ZPL programmer's guide to verify and use the correct command usage and syntax.</p>
	<p>The prefix and delimiter characters set in the printer do not match the ones in the label format. Verify that the ZPL programming settings of the Control, Command, and Delimiter settings are correct for your system software environment. Print a Configuration Report or use display's Language Menu (if present) for these three menu items and compare it the commands in the label format/form you are trying to print. See Testing Printing with the Configuration Report on page 59 and ZPL Configuration on page 168.</p>
	<p>The MLB (Main Logic Board) may be malfunctioning. Firmware is corrupted, or the MLB needs service.</p> <ul style="list-style-type: none"> • Reset the printer to factory defaults. Use the Zebra Setup Utility and select Open Printer Tools > Action > Load printer defaults. • Reload printer firmware. See Updating Printer Firmware on page 109. • If the printer does not recover from this error, call a service technician.

Troubleshooting

Issue	Possible Cause(s) and Remedies
<p>Non-continuous labels are treated as continuous labels.</p> <p>A non-continuous label format with matching media loaded in the printer, was sent to the printer, but it prints like it is continuous media.</p>	<p>The printer was not calibrated for the media being used, or the printer is configured for continuous media. Set the printer for the correct media type (gap/notch, continuous, or mark) and calibrate the printer using Running a SmartCal Media Calibration on page 58, if necessary use Manually Calibrating Media on page 151 for hard-to-calibrate media types.</p>
<p>Printer locks up.</p> <p>All indicator lights are on and the printer locks up or the printer locks up while restarting.</p>	<p>All indicator lights are on and the printer locks up or the printer locks up while restarting. Printer memory may be corrupted. Try these solutions:</p> <ul style="list-style-type: none"> • Reset the printer to factory defaults. See use the Zebra Setup Utility and select Open Printer Tools > Action > Load printer defaults. • Reload printer firmware. See Updating Printer Firmware on page 109). • If the printer does not recover from this error, call a service technician.
<p>Battery shows a red indicator, indicating a fault</p>	<p>The battery has reached its usable life or has a general component failure. Replace the battery.</p>
	<p>Battery is too hot or too cold. Remove the battery from the printer and check charge status by charging the battery. Let the battery cool down or warm up to ambient temperature, then recheck the battery charge. If the problem is not with the battery charge status or temperature, replace the battery.</p>

Tools

A variety of diagnostic, adjustment, and programming tools and utilities are built into your printer. They are designed to help you with setup, configuration, and debugging using specifically-timed button presses and programming commands.

Printer Diagnostics

You can use several diagnostic options to determine printer status. These include diagnostic reports, calibration procedures, and factory default resets.



NOTE: Many diagnostic tests require that you have media loaded in the printer. Use full-width media when performing self tests. If your media is not wide enough, the test labels may print on the platen (drive) roller.

During the diagnostic tests:

- Do not send data to the printer from the host when performing these self tests.
- Know that if your media is shorter than the label to be printed, the test output will continue to print on the next label.
- If you cancel a self test prior to completion, remember to reset the printer by turning printer power OFF and then ON.
- If the printer is in Dispense mode and the liner is being taken up, manually remove the labels as they are printed.

A diagnostic self test is typically performed by pressing a specific user interface button or a combination of the buttons while turning printer power ON. Keep the button(s) pressed until the first indicator light turns off. The selected self-test will automatically begin when the printer completes its power-on self test.

Power-On Self Test

The printer performs the power-on self test on power-up.

During this test sequence, all control panel indicators turn on and off to test operational readiness. Only the Status indicator () remains lit when the self test is completed.

Activating SmartCal Media Calibration

Use the SmartCal media calibration feature of your printer to quickly calibrate it to the media that is currently loaded in your printer.

During this procedure, the printer automatically determines the media sensing type (gap, black line, or notch) and measures the length of the media that is loaded.

1. Make sure media is properly loaded, the printer cover is closed, and printer power is ON.
2. Press and hold **PAUSE** () and **CANCEL** () simultaneously for two seconds.

The printer feeds media and measure several labels and returns to Ready status.

If the printer fails to recognize and correctly calibrate to the media, see [Manually Calibrating Media](#) on page 151.

Printing the Printer Configuration Report (CANCEL Self Test)

The Configuration Report diagnostic procedure prints a set of printer and network configuration reports.

1. Make sure media is loaded, the printer cover is closed, and printer power is ON.
2. If printer power is OFF, press and hold **CANCEL** () and turn printer power ON. Hold the button down until the Status indicator is the only indicator lit.

3. With printer power ON, press **FEED** () and **CANCEL** () for two seconds.

The printer outputs the Printer Configuration and Network Configuration reports, and returns to Ready state.

PRINTER CONFIGURATION	
Zebra Technologies	
ZTC ZD410-300dpi ZPL	
50J153200130	
+20.0.....	DARKNESS
LDM.....	DARKNESS SWITCH
4.0 IPB.....	PRINT SPEED
+000.....	TEAR OFF
TEAR OFF.....	PRINT MODE
MARK.....	MEDIA TYPE
REFLECTIVE.....	SENSOR SELECT
540.....	PRINT WIDTH
1104.....	LABEL LENGTH
39.0IN 989MM.....	MAXIMUM LENGTH
MAINT. OFF.....	EARLY WARNING
NOT CONNECTED.....	USB COMM.
AUTO.....	SER COMM. MODE
9600.....	BAUD
8 BITS.....	DATA BITS
NONE.....	PARITY
NON/XOFF.....	HOST HANDSHAKE
NONE.....	PROTOCOL
NORMAL MODE.....	COMMUNICATIONS
<^> FEH.....	CONTROL PREFIX
<^> BEH.....	FORMAT PREFIX
<.> ECH.....	DELIMITER CHAR
ZPL II.....	ZPL MODE
INACTIVE.....	COMMAND OVERRIDE
NO MOTION.....	MEDIA POWER UP
FEED.....	HEAD CLOSE
DEFAULT.....	BACKFEED
+000.....	LABEL TOP
+0000.....	LEFT POSITION
DISABLED.....	REPRINT MODE
042.....	WEB SENSOR
055.....	MEDIA SENSOR
128.....	TAKE LABEL
070.....	MARK SENSOR
004.....	MARK RED SENSOR
000.....	TRANS GAIN
100.....	TRANS LED
066.....	MARK GAIN
058.....	MARK LED
DPCSWFM.....	MODES ENABLED
	MODES DISABLED
840 127PI FULL.....	RESOLUTION
3.0.....	LINK-OS VERSION
V77.18.142	← FIRMWARE
1.3.....	XML SCHEMA
6.5.0 0.515.....	HARDWARE ID
8132k.....R:	RAM
55536k.....E:	ONBOARD FLASH
NONE.....	FORMAT CONVERT
ENABLED.....	IDLE DISPLAY
01/01/70.....	RTC DATE
01:11.....	RTC TIME
DISABLED.....	ZBI
2.1.....	ZBI VERSION
READY.....	ZBI STATUS
312 LABELS.....	NONRESET CNTR
312 LABELS.....	RESET CNTR1
312 LABELS.....	RESET CNTR2
1.593 IN.....	NONRESET CNTR
1.593 IN.....	RESET CNTR1
1.593 IN.....	RESET CNTR2
4.047 CM.....	NONRESET CNTR
4.047 CM.....	RESET CNTR1
4.047 CM.....	RESET CNTR2
EMPTY.....	SLOT 1
0.....	MASS STORAGE COUNT
0.....	HID COUNT
OFF.....	USB HOST LOCK OUT
FIRMWARE IN THIS PRINTER IS COPYRIGHTED	

Network Configuration	
Zebra Technologies ZTC ZD410-300dpi ZPL 50J153200130	
Wired.....	PRIMARY NETWORK
PrintServer.....	LOAD LAN FROM?
WIRELESS.....	ACTIVE PRINTSRVR
Wireless*	
ALL.....	IP PROTOCOL
172.029.016.066...	IP ADDRESS
255.255.255.000...	SUBNET
172.029.016.001...	GATEWAY
172.029.001.003...	WINS SERVER IP
YES.....	TIMEDOUT CHECKING
300.....	TIMEDOUT VALUE
000.....	ARP INTERVAL
8100.....	BASE RAW PORT
8200.....	JSON CONFIG PORT
INSERTED.....	CARD INSERTED
02aff.....	CARD PFB ID
8194H.....	CARD PRODUCT ID
ac13f1a4:00:0f:140..	MAC ADDRESS
YES.....	DRIVER INSTALLED
INFRASTRUCTURE.....	OPERATING MODE
129.....	ESSID
.....	CURRENT TX RATE
OPEN.....	WEP TYPE
NONE.....	WLAN SECURITY
1.....	WEP INDEX
000.....	POWER SIGNAL
LDNB.....	PREAMBLE
YES.....	ASSOCIATED
ON.....	PULSE ENABLED
15.....	PULSE RATE
OFF.....	INTL MODE
usa/canada.....	REGION CODE
usa/canada.....	COUNTRY CODE
0x3f7fffffff.....	CHANNEL MASK
Bluetooth	
4.3.1p1.....	FIRMWARE
02/13/2015.....	DATE
on.....	DISCOVERABLE
3.0/4.0.....	RADIO VERSION
on.....	ENABLED
AC13F1A4:00:0F:140..	MAC ADDRESS
50J153200130.....	FRIENDLY NAME
no.....	CONNECTED
1.....	PIN SECURITY MODE
no.....	CONN SECURITY MODE
supported.....	IDS
FIRMWARE IN THIS PRINTER IS COPYRIGHTED	

When the Wi-Fi and Bluetooth Classic wireless connectivity option is installed on your printer, iOS devices can connect to your printer with Bluetooth Classic 4.x (with 3.0 compatibility). The Bluetooth section of the Network Configuration report reads *supported*.

Some ZD series printers only have the Bluetooth LE (without Wi-Fi and classic Bluetooth). If that is the case or the wireless connectivity option is NOT installed, the iOS setting in the Bluetooth section of the Network Configuration report reads *not supported*.

Network and Bluetooth Configuration Report

ZD Series printers with wired or wireless connectivity options installed will print an additional printer configuration report. You will need this information to establish and troubleshoot Ethernet (LAN and WLAN), Bluetooth 4.1, and Bluetooth LE network printing.

A sample of the report printed using the ZPL `~WL` command is shown below.

```

Network Configuration
Zebra Technologies
ZTC ZD410-300dpi ZPL
50.J153200130

Wired..... PRIMARY NETWORK
PrintServer..... LOAD LAN FROM?
WIRELESS..... ACTIVE PRINTSRVR

wireless#
ALL..... IP PROTOCOL
172.029.018.066... IP ADDRESS
255.255.255.000... SUBNET
172.029.018.001... GATEWAY
172.029.001.003... WINS SERVER IP
YES..... TIMEOUT CHECKING
300..... TIMEOUT VALUE
000..... ARP INTERVAL
8100..... BARE RAW PORT
9800..... JSON CONFIG PORT
INSERTED..... CARD INSERTED
06d/h..... CARD PPS ID
8194..... CARD PRODUCT ID
ac13f1a410010f140.. MAC ADDRESS
YES..... DRIVER INSTALLED
INFRASTRUCTURE..... OPERATING MODE
125..... ESSID
1..... CURRENT TX RATE
OPEN..... WEP TYPE
NONE..... WLAN SECURITY
1..... WEP INDEX
000..... PWR SIGNAL
LONB..... PREABLE
YES..... ASSOCIATED
ON..... PULSE ENABLED
15..... PULSE RATE
OFF..... INTL MODE
usa/canada..... REGION CODE
usa/canada..... COUNTRY CODE
0x3f7fffff..... CHANNEL MASK

Bluetooth
4.3.ip1..... FIRMWARE
02/13/2015..... DATE
on..... DISCOVERABLE
3.04.0..... RADIO VERSION
on..... ENABLED
AC13F1A410010F141.. MAC ADDRESS
50.J153200130..... FRIENDLY NAME
no..... CONNECTED
1..... WLN SECURITY MODE
no..... CWN SECURITY MODE
supported..... IDS

FIRMWARE IN THIS PRINTER IS COPYRIGHTED

```

1	iOS support setting
---	---------------------

Printing a Print Quality Report (FEED Self-Test)

Different types of media may require different darkness settings. Use this simple but effective method for determining the ideal darkness for printing barcodes that are within specifications.

During the FEED self-test, the printer prints a series of labels at different darkness settings at two different print speeds. The barcodes on these labels may be ANSI-graded to show print quality.

During this test, one set of labels is printed at low speed, and another set is printed at the high speed. The darkness value starts at three settings lower than the printer's current darkness value (relative darkness of -3) and increase until the darkness is three settings higher than the current darkness value (relative darkness of +3).

Each label shows the relative darkness and the print speed.

The speed at which labels are printed during this print quality test depends on the dot density of the printhead.

- 300 dpi printers: prints 7 labels at 51mm/sec (2 ips) and 102 mm/sec (4 ips) print speeds
- 203 dpi printers: prints 7 labels at 51mm/sec (2 ips) and 152 mm/sec (6 ips) print speeds

Printing a Print Quality Report

You can print a configuration report to use as a reference on the printer's current settings.

1. Press and hold **FEED** () and **CANCEL** () simultaneously for two seconds.
2. Turn printer power OFF.

- Press and hold **FEED** () while turning printer power ON. Keep pressing the button until the status indicator is the only indicator that is lit.

The printer prints a series of labels at various speeds and darkness settings that are higher and lower than the darkness value shown on the configuration label.

Figure 10 Print Quality Report



4. Inspect the test labels and determine which one has the best print quality for your application.
 - a) If you have a barcode verifier, use it to measure bars and spaces and calculate the print contrast.
 - b) If you do not have a barcode verifier, use your eyes or the system scanner to choose the optimal darkness setting based on the labels printed in this self test. (See [Figure 11 Barcode Darkness Comparison](#) on page 146 and [Table 1 Visual Darkness Descriptions](#) on page 146.)

Figure 11 Barcode Darkness Comparison

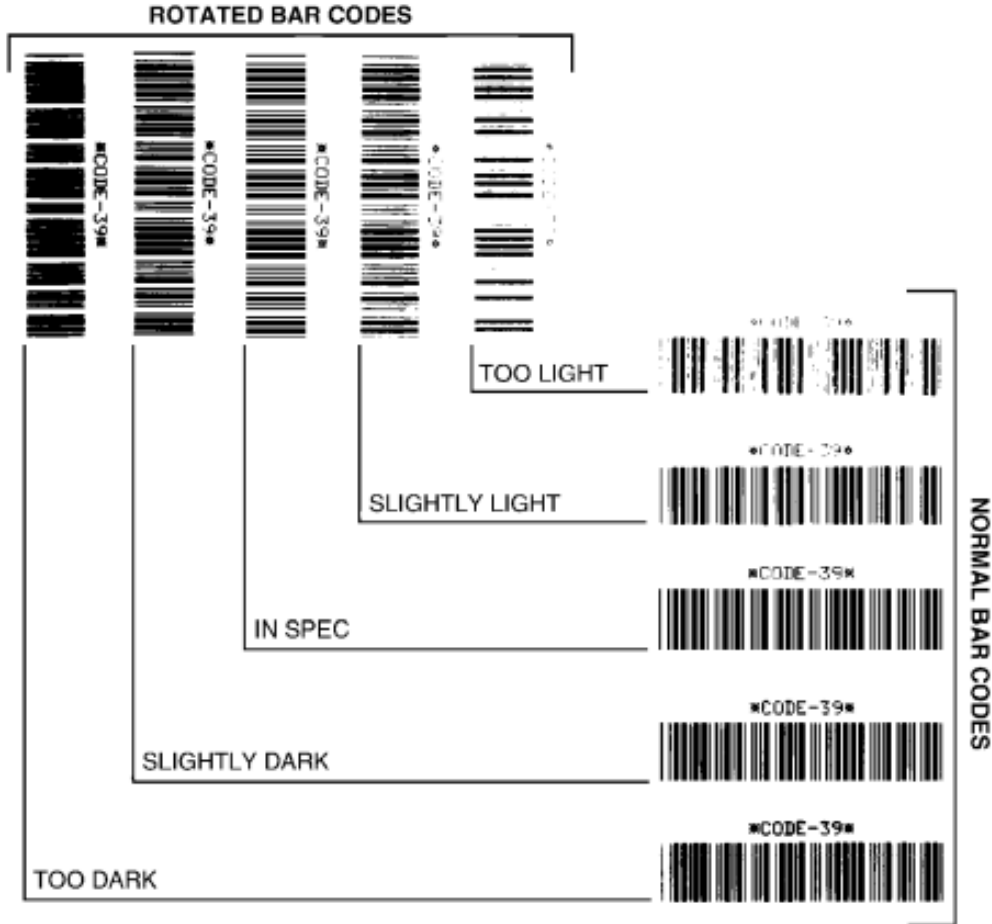

Table 1 Visual Darkness Descriptions

Print Quality	Description
Too dark	Labels that are too dark are fairly obvious. They may be readable but not 'in-spec.' The normal barcode bars increase in size. The openings in small alphanumeric characters may appear filled in. Rotated barcode have bars and spaces run together.

Table 1 Visual Darkness Descriptions (Continued)

Print Quality	Description
Slightly dark	<p>Slightly dark labels are not as obvious.</p> <p>The normal barcode will be 'in-spec'.</p> <p>Small character alphanumeric characters will appear bold and could be slightly filled in.</p> <p>The rotated barcode spaces are small when compared to the 'in-spec' code, possibly making the code unreadable.</p>
"In-spec"	<p>The 'in-spec' barcode can only be confirmed by a verifier, but it should exhibit the following visible characteristics.</p> <ul style="list-style-type: none"> • The normal barcode will have complete, even bars and clear, distinct spaces. • The rotated barcode will have complete, even bars and clear, distinct spaces. Although it may not look as good as a slightly dark barcode, the barcode will be 'in-spec'. • In both normal and rotated styles, small alphanumeric characters look complete.
Slightly light	<p>Slightly light labels are, in some cases, preferable to slightly dark ones for 'in-spec' barcodes.</p> <p>Slightly light labels are, in some cases, preferable to slightly dark ones for 'in-spec' barcodes.</p> <p>Both normal and rotated barcodes will be in spec, but small alphanumeric characters may not be complete.</p>
Too light	<p>Labels that are too light are obvious.</p> <p>Both normal and rotated barcodes have incomplete bars and spaces.</p> <p>Small alphanumeric characters are unreadable.</p>

5. Note the relative darkness value and the print speed printed on the best test label.
6. Add or subtract the relative darkness value from the darkness value specified on the Printer Configuration label. The resulting numeric value is the best darkness value for that specific label and print speed combination.
7. If necessary, change the current darkness value of the printer to the darkness value on the best test label. See [Manual Print Darkness Adjustment](#) on page 153.
8. If necessary, change the current print speed to the speed value on the best test label. See two options for how to do this in [Adjust the Print Quality](#) on page 96.

Resetting Non-Network Printer Configuration Settings to their Factory Defaults

Use these instructions to reset the non-network printer settings to their factory defaults.

1. Turn printer power OFF.
2. Press and hold **PAUSE** () and **FEED** () simultaneously and turn printer power ON.

3. Continue holding these buttons until the STATUS indicator () is the only indicator lit.





NOTE: The printer has a **RESET** button on its underside. See [Reset Button Functions](#) on page 148 for information on how to use this button.

After the non-network printer configuration settings are reset, calibrate the sensor. See [Running a SmartCal Media Calibration](#) on page 58 and [Manually Calibrating Media](#) on page 151.

Resetting the Printer's Network Settings to Their Factory Defaults

Use this procedure to reset only the printer's network settings to their factory defaults.

1. Turn printer power OFF.
2. Press and hold **PAUSE** () and **CANCEL** () simultaneously and turn printer power ON.
3. Continue holding these buttons until the Status indicator () is the only indicator that is lit.

The printer's network configuration is reset to factory defaults. The printer does not output Printer or Network Configuration labels at the end of this procedure.

Reset Button Functions

Your printer has a dedicated **RESET** button on its lower surface which is pressed using a paper clip or similar small object.

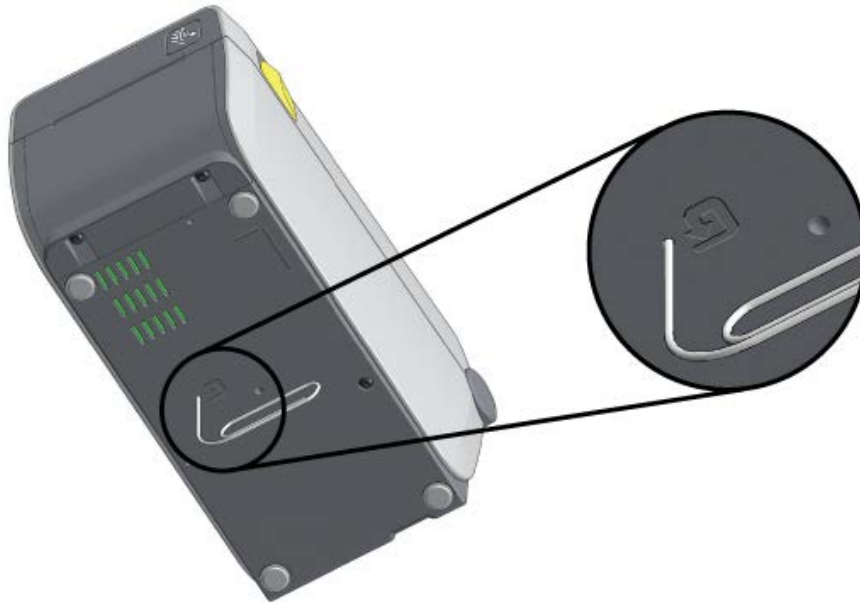

Press the **RESET** button for the length of time specified below as needed to perform the listed functions.

1 second or under	No effect.
1–5 seconds (printer reset)	The printer performs a factory reset, then prints a Printer Configuration label (and a Network Configuration label if connected to a network).

6–10 seconds (network connection reset, for printers connected to a network)	The printer drops the network connection, resets its network settings to their factory defaults, and prints a Printer Configuration label and a Network Configuration label.
More than 10 seconds (Reset mode exit)	The printer does NOT reset. The printer and network parameters are left unchanged.

Performing a Communication Diagnostics Test



This is a troubleshooting test used to check the connection between the printer and its host computer or device.

When the printer is in Diagnostics mode, it prints all data received from the host computer as straight ASCII characters, with the hex values printed below the ASCII text. The printer prints all the characters it receives. This includes control codes such as CR (carriage return). The test label prints upside-down as it exits the printer.

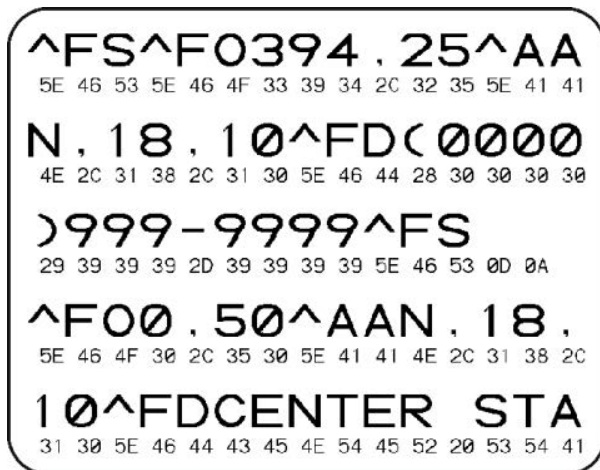
Figure 12 Typical Communications Diagnostics Test Label



To print this test label:

1. Ensure media is loaded and printer power is ON.
2. Set the print width equal to, or less than, the width of the label being used for the test.
3. Press and hold **PAUSE** () and **FEED** () simultaneously for two seconds.

When active, the Status indicator () alternately lights up Green and Yellow.



The printer enters Diagnostics mode and prints any data received from the host computer or management device on a test label.

4. Check the test label for error codes. If any errors are shown, verify if the communication parameters are correctly set.

Errors show on the test label as follows:



FE	Framing error
OE	Overrun error

PE	Parity error
NE	Noise

- to exit the self-test and return to normal operations, press and hold **PAUSE** () and **FEED** () simultaneously for two seconds, or turn printer power OFF and back ON.

Sensor Profile

Use the sensor profile image—which typically prints across several labels or tags—for diagnostics if the printer is not accurately sensing gaps between labels or if it incorrectly identifies pre-printed areas on a label as gaps.

To print a sensor profile using the printer buttons, turn printer power OFF, then turn printer power on while holding down **FEED** () and **CANCEL** () simultaneously. Continue pressing these buttons until the Status indicator is the only indicator that remains lit.

To print the sensor profile using Zebra Programming Language (ZPL), send a `~JG` command to the printer. See the ZPL Programming Guide for more information on this command.

Compare your results to the examples shown in [Performing a Communication Diagnostics Test](#) on page 149. If sensor sensitivity must be adjusted, calibrate the printer. See [Manually Calibrating Media](#) on page 151.

Figure 13 Sensor Profile (Gap Media)

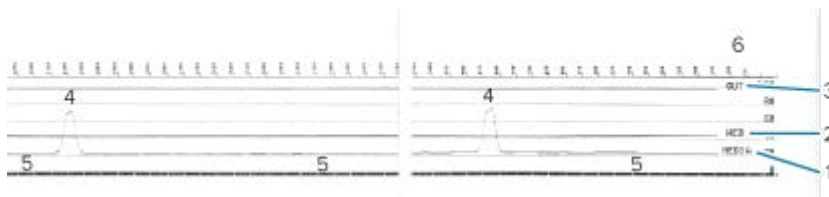
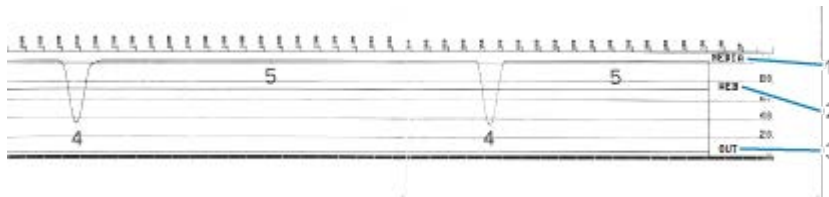

Figure 14 Sensor Profile (Black Mark Tag Media)



1	MEDIA (media sensor readings line)
2	WEB (media sensor threshold settings line)
3	OUT (media out threshold line)
4	Upward spikes indicating gaps between labels (the 'web')
5	Lines between the spikes (indicate where labels are located)
6	Measurement in dots (from the start of the printout)





Compare the sensor profile printout to a length of one media form (ex., a label). The spikes should be the same distance apart as the gaps are situated on the media.



NOTE: If the gap distances are not the same, the printer may be having difficulty determining where the gaps are located.

Activating Advanced Mode

Use Advanced mode to access the printer's manual adjustment modes.

1. Ensure media is loaded and printer power is turned ON.
2. Press **PAUSE** () for two seconds.
All indicators flash yellow. The Status indicator () lights solid yellow, indicating Manual Media Calibration mode is selected.
3. To sequentially cycle through the available modes, press **FEED** ().
4. To activate the selected mode, press **PAUSE** ().
5. To exit Advanced mode, press **CANCEL** ().

Manually Calibrating Media



Use these steps to manually calibrate the printer for the loaded media.

This Advanced mode is typically used to calibrate the printer to media that is not correctly recognized during Smart Calibration.

You may have to perform this manual calibration several times, moving the media sensor each time, until the printer completes the calibration process and returns to ready state.

To manually calibrate the printer to the media:

1. Place the printer in Advanced Mode (see [Activating Advanced Mode](#) on page 151) and press **PAUSE** () while the Status indicator () is lit yellow.

The Supplies indicator () flashes yellow, after which the Pause indicator () flashes.

2. Open the printer and verify the media sensor is in the center position for label/gap (transmissive) sensing.

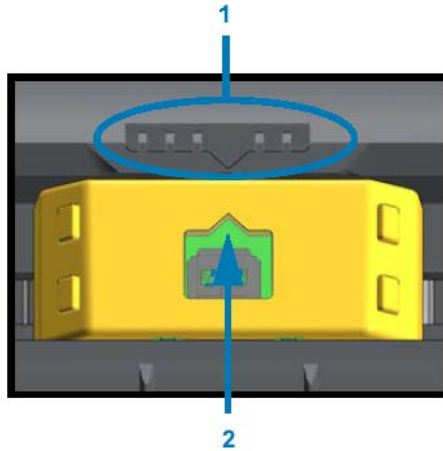





Figure 15

1	Sensor alignment key
2	Alignment arrow (default position)





NOTE: For black-mark or notch media, set the media sensor to the proper location to sense the mark or notch. For pre-printed media with print either on the front of the label or on the back of the liner, position the sensor to a place where it will minimally sense (that is, encounter) the pre-print.

3. Remove 80 mm (3 in.) of labels from the liner, then place the label-free area of the liner over the platen (drive) roller such that the leading edge of the first label is under the media guides.
4. Close the printer and press **PAUSE** () one time.
The Media indicator () flashes while the printer measures the media liner. When complete, the Pause indicator () begins to flash.
5. Open the printer and reposition the media to locate a label directly above the movable sensor.
6. Close the printer and press **PAUSE** () one time.

The printer feeds and measures several labels. If it is able to determine the correct media type (gap, black mark, or notch) and measure the media length, it returns to Ready state.

Manual Print Width Adjustment

You can manually adjust the print width for your printer depending on your printing needs.

Place the printer in Advanced mode. See [Activating Advanced Mode](#) on page 151. Then press **PAUSE** () while the Pause indicator () lights up yellow.



The printer prints a 16 mm (0.63 in.) box, pauses momentarily, prints a slightly larger box, and pauses again, and so on.

When you see the printer print a box that matches the width of your media, press **FEED** () to select that print width and return the printer to Ready state for printing.

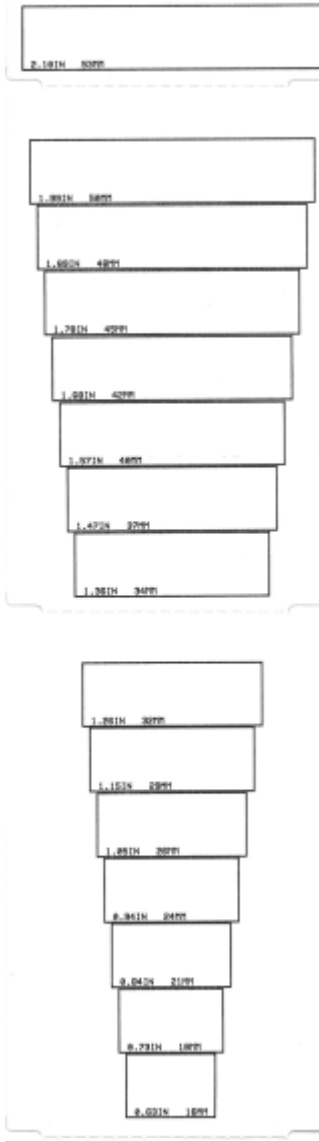
To return to the maximum print width setting, refrain from pressing **FEED** () and allow the printer to proceed until it reaches that width.



Manual Print Darkness Adjustment

To initiate a Manual Print Darkness Adjustment, press **PAUSE** () while the data indicator () is illuminated yellow.

The printer will print a test pattern showing the current darkness number and several barcode patterns and then pause momentarily. It will then repeat the pattern with the next darkness level.



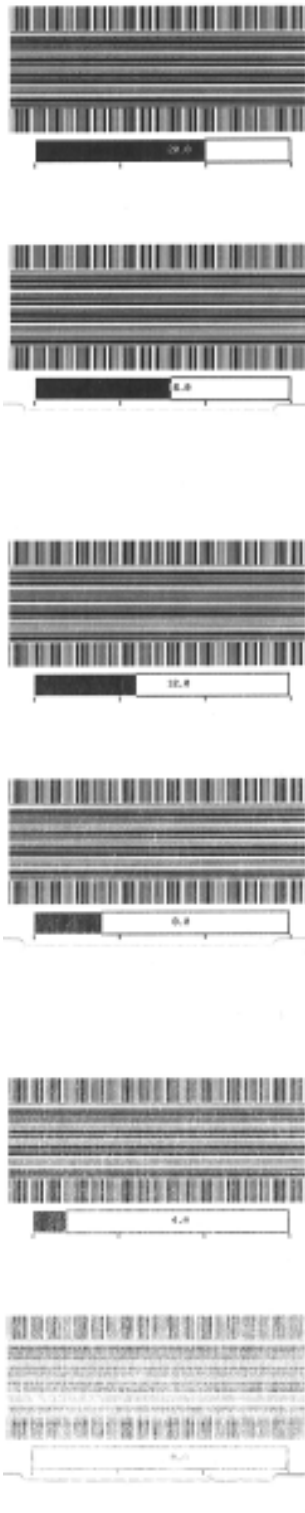

When you see the printer print a pattern with solid, even black lines, press **FEED** () to set the darkness to that value and return the printer to Ready state.



Factory Test Modes

When placed in these modes, the printer begins printing various test patterns which you can use to evaluate printer performance.

Your ZD series printer comes with the following print modes which are intended for factory tests:

Test mode 1	Hold PAUSE () when turning printer power ON to initiate this mode.
Test mode 2	Hold PAUSE (), FEED (), and CANCEL () all simultaneously for two seconds with printer power ON to initiate this mode.



NOTE: These test modes consume a considerable amount of media.

To exit either mode, press and hold **POWER** () while switching printer power OFF. Release the button when the printer has fully powered down.

Interface Connector Wiring

Use the information in this section to identify the pinouts needed for USB and Serial Port interface connections.

Universal Serial Bus (USB) Interface

Review the cable wiring and pinouts you will need to use the printer's USB interfaces.



IMPORTANT: When using third-party USB cables to connect the printer, look for cables or cable packaging that bears the Certified USB™ mark as a guarantee of USB 2.0 compliance. See usb.org for details.

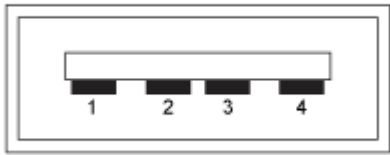
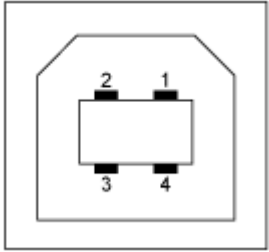

The A-type connector is shown on the left, and the B-type connector is shown on the right.

USB Connector "A" Wiring	Pin no.	USB Connector "B" Wiring
		
Vbus (+5V DC)	1	Vbus (not connected)
D- (data signal, negative side)	2	D- (data signal, negative side)
D+ (data signal, positive side)	3	D+ (data signal, positive side)
Shell (shield/drain wire) shell	4	Shell (shield/drain wire) shell



IMPORTANT: USB Host +5 VDC power source is shared with serial port phantom power. It is limited to 0.5mA per USB specification and with on-board current limiting. The maximum current available through the serial port and USB port will not exceed a total of 0.75 Amps.

Serial Port Interface

The following table lists pinouts for the Zebra Auto-Detecting DTE and DCE feature as it relates to the 9-Pin RS-232 Interface:

Pin	DTE	DCE	Description (DTE)
1	—	5V	Not used.
2	RXD	TXD	Receive data (RXD) input to the printer.
3	TXD	RXD	Transmit data (TXD) output from the printer.
4	DTR	DSR	Data terminal ready (DTR) output from the printer—controls when the host may send data.
5	GND	GND	Circuit ground.
6	DSR	DTR	Data set ready (DSR) input to the printer.
7	RTS	CTS	Request to send (RTS) output from the printer—always active when printer power is on.
8	CTS	RTS	Clear to send (CTS)—Not used by the printer.
9	5V	—	+5 V @ 0.75 A—FET Circuit current limited.



IMPORTANT: The maximum current available through the serial port, USB port, or both will not exceed a total of 0.75 Amps.

If you select XON/XOFF handshaking during printer driver setup, data flow will be controlled by ASCII control codes DC1 (XON) and DC3 (XOFF). The DTR control lead will have no effect.

The printer is configured as a Data Terminal Equipment (DTE) device. To connect the printer to other DTE devices such as the serial port of a personal computer, use an RS-232 null modem (crossover) cable and the pinouts shown below.

Connecting the Printer to a DTE Device

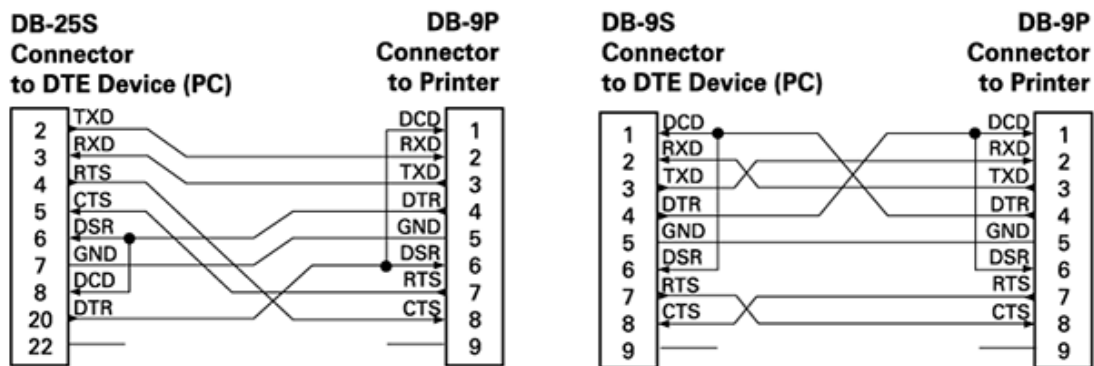

When connecting the printer through its RS-232 interface to any Data Communication Equipment (DCE) units such as a modem, use a standard RS-232 (straight-through) interface cable and the pinouts shown below.

Connecting the Printer to a DCE Device

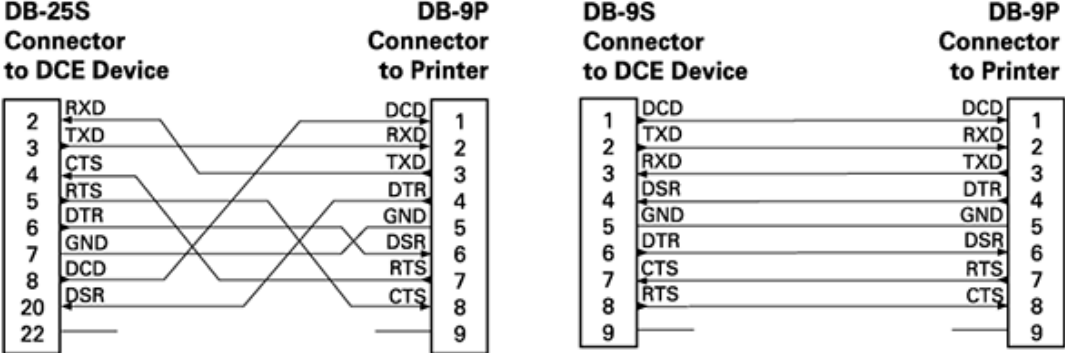

Dimensions

This section provides external printer dimensions. All dimensions shown are in millimeters (mm).

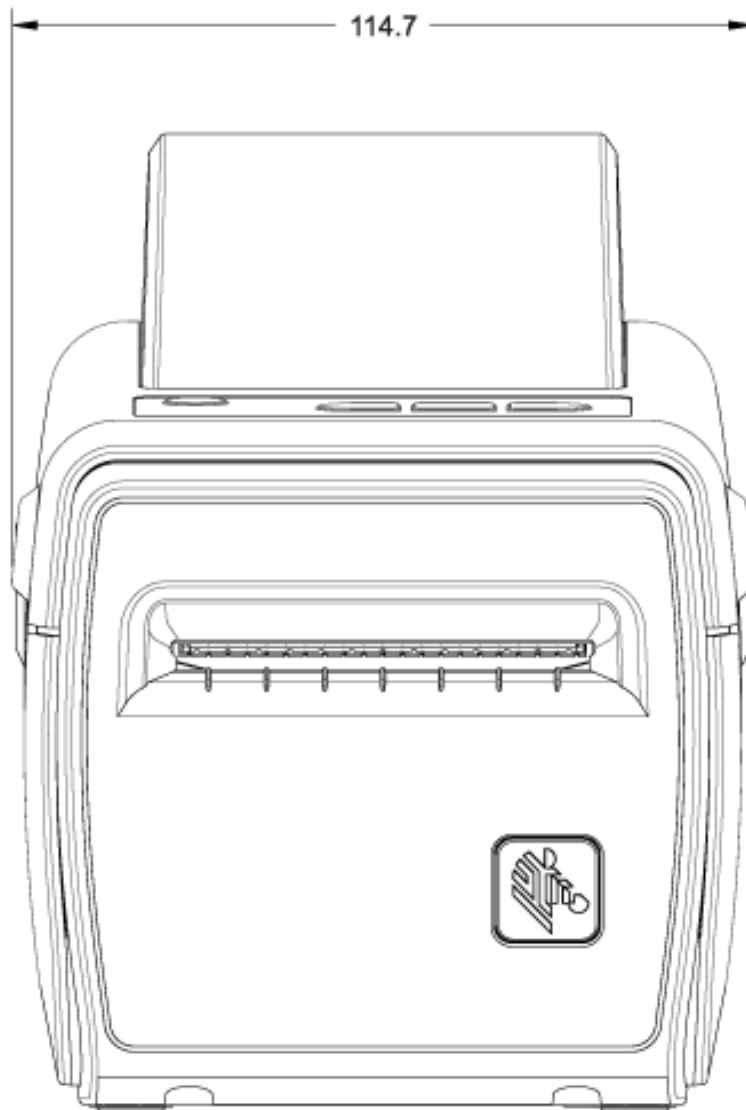

Dimensions

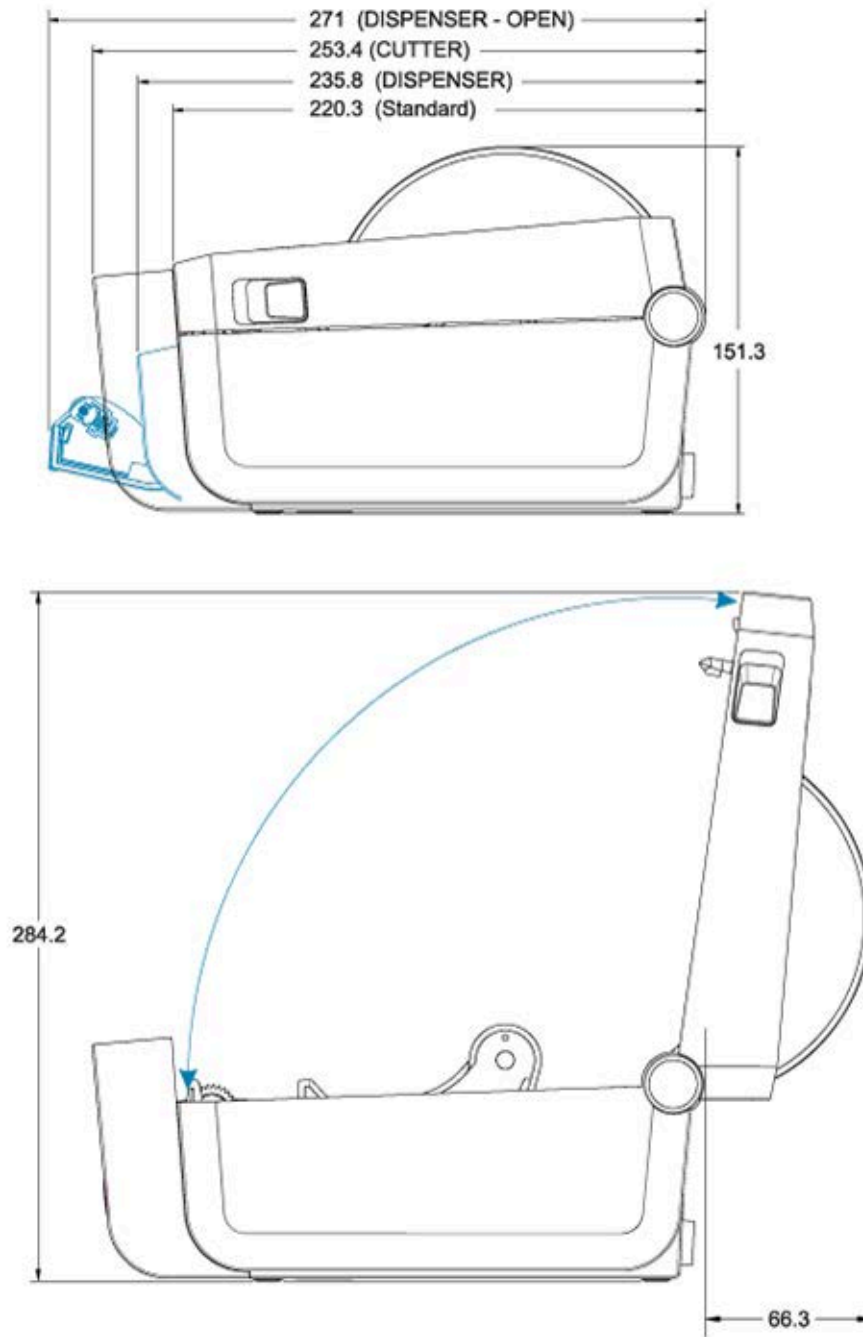

The printer dimensions when it has a battery base and battery attached are shown in the two images that follow. All dimensions are in millimeters (mm).

Dimensions

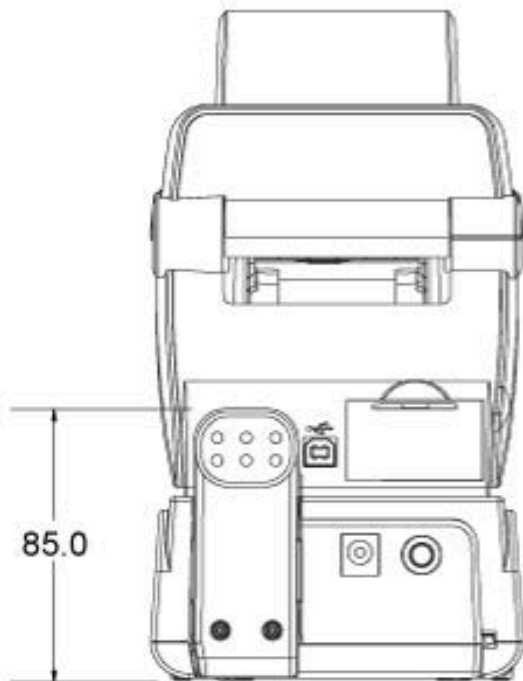
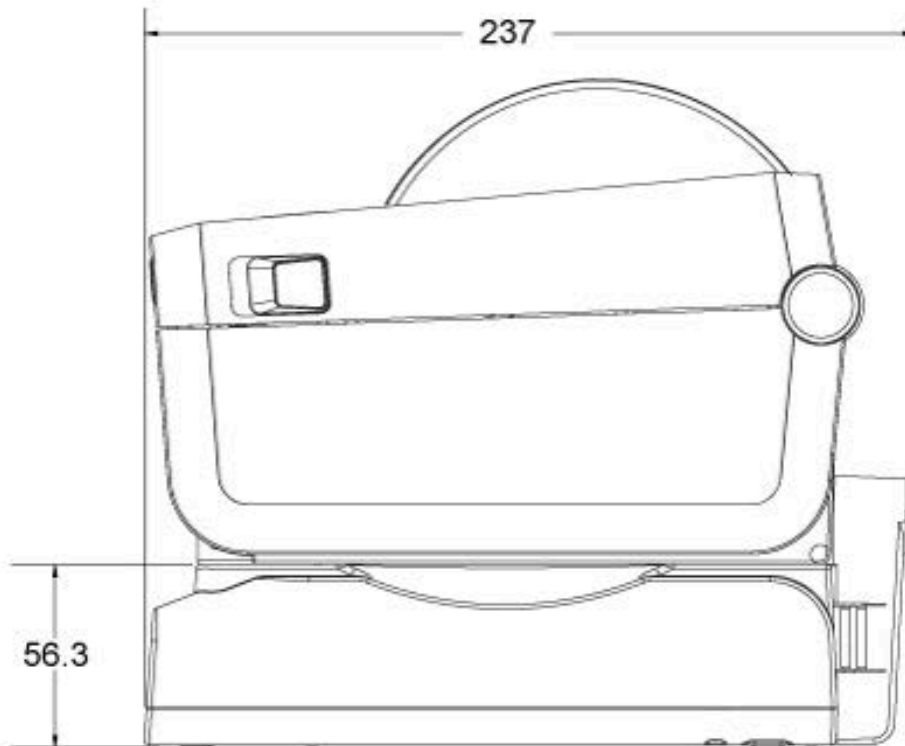

Dimensions

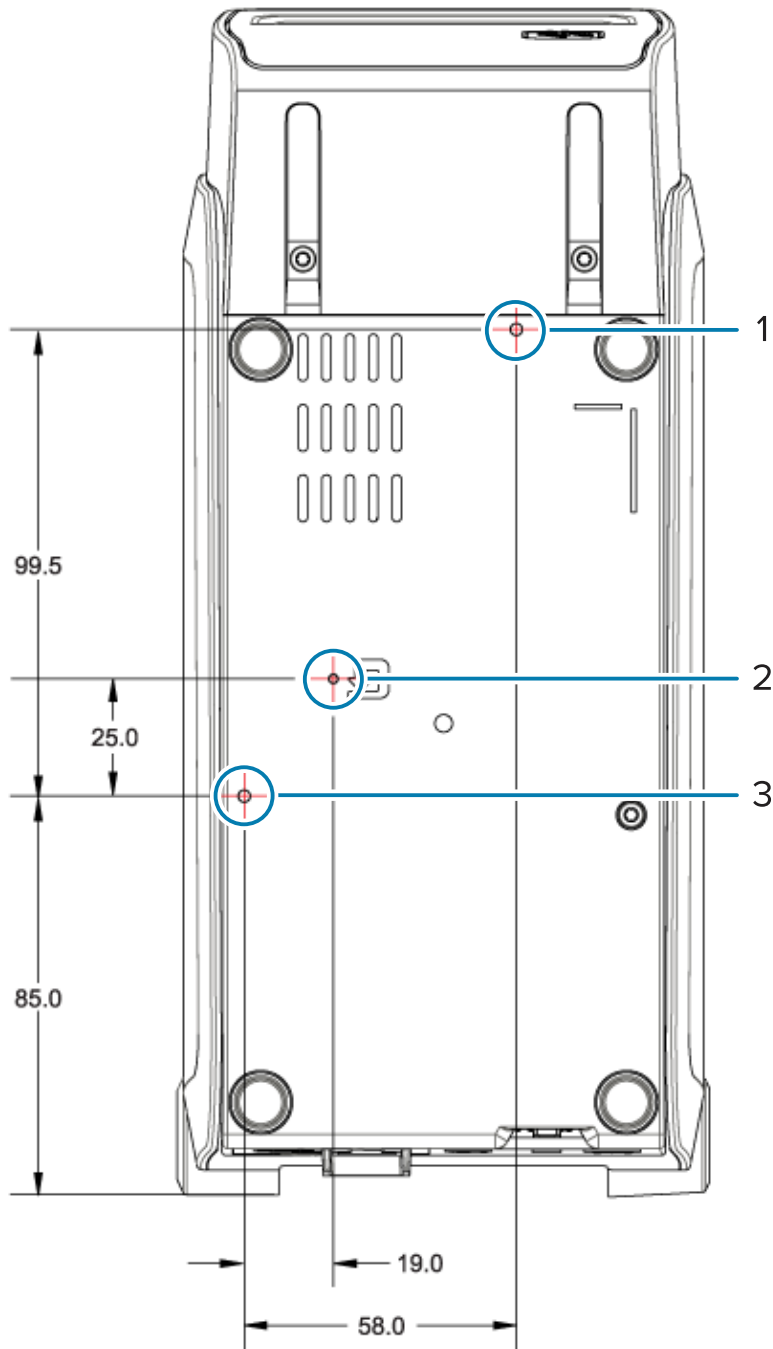

1	Upper mounting hole
2	Hardware reset access (provide 20-25 mm hole in mounting plate or surface)
3	Lower mounting hole

Use ONLY M3 thread-forming screws with a maximum hole depth of 5 mm to mount the printer to the base.



IMPORTANT: Do NOT remove the rubber feet on the printer base. This may cause the printer to overheat.

Media

This section provides an overview of the types of media available to use with your printer.

Types of Thermal Media

Zebra strongly recommends the use of Zebra-brand supplies for consistent high-quality printing. A wide range of paper, polypropylene, polyester, and vinyl stock has been specifically engineered by Zebra to enhance the printing capabilities of your printer and prevent premature wear of your printhead.

Your printer typically uses roll media. It also supports fanfold or other continuous media. To purchase media and other supplies for your printer, go to zebra.com/supplies.

Your printer can use various types of media:

Standard media	Most standard (non-continuous) media uses an adhesive backing that sticks individual labels or a continuous length of labels to a liner.
Continuous roll media	Most continuous roll media is direct thermal media (similar to fax paper) and is used for receipt or ticket style printing.
Tag stock	Tags are usually made from a heavy paper (up to 0.19mm or 0.0075in. thick). Tag stock does not have adhesive or a liner, and typically features perforations between tags.

For more information on basic media types and specifications, see [General Media and Print Specifications](#) on page 165.

Performing a Media Scratch Test

Thermal transfer media requires ribbon for printing while direct thermal media does not. To determine if you have direct thermal media used by your printer, perform a media scratch test.

1. Scratch the print surface of the media with a fingernail or pen cap. Press firmly and quickly while dragging the fingernail or pen cap across the media surface.

Direct thermal media is chemically treated to print (expose) when heat is applied. This test method uses friction heat to expose the media.

2. Check if a black mark appears on the media? If it does, the media is of a Direct Thermal type and ribbon is NOT required for printing. If no mark appears, the media is of a Thermal Transfer type and a ribbon is required to print on this media—your ZD410d printer does not support printing on this type of media.

General Media and Print Specifications

Media thickness	<ul style="list-style-type: none"> • 0.08 mm (0.003 in.) min – all requirements • 0.1905 mm (0.0075 in.) max – all requirements
Media width	<ul style="list-style-type: none"> • 60 mm (2.36 in.) max • 15 mm (0.585 in.) min
Media length	<ul style="list-style-type: none"> • 990 mm (39 in.) max • 6.35 mm (0.25 in.) min for tear-off media or labels • 12.7 mm (0.50 in.) min for media that will use the optional peel dispenser • 25.4 mm (1.0 in.) min for media that will use the optional cutter
Media roll Outer Diameter (O.D.) max	127mm (5 in.)
Media roll core Inner Diameter (I.D.)	<ul style="list-style-type: none"> • 12.7 mm (0.5 in.) I.D. for the standard roll configuration • 25.4 mm (1 in.) I.D. for the standard roll configuration • 38.1 mm (1.5 in.) I.D. for the optional media roll adapter • 50.8 mm (2.0 in.) I.D. for the optional media roll adapter • 76.2 mm (3.0 in.) I.D. for the optional media roll adapter
Print width	<ul style="list-style-type: none"> • 1 dot (ZPL) min. • 56 mm (2.20 in.) max @ 203 dpi • 54 mm (2.12 in.) max @ 300 dpi
Dot pitch	<ul style="list-style-type: none"> • 203 dpi: 0.125 mm (0.0049 in.) • 300 dpi: 0.085 mm (0.0033 in.)
Barcode modulus x-dim	<ul style="list-style-type: none"> • 203 dpi: 0.005 – 0.050 in. • 300 dpi: 0.00327 – 0.03267 in.

Table 2 Types of Media Roll and Fanfold Media



Media type	How it looks	Description
<p>Non-continuous roll media</p>		<p>Labels have adhesive backing that sticks them to a liner. Tags (or tickets) are separated by perforations.</p> <p>Individual labels or tags are tracked and position controlled by one or more of the following methods:</p> <ol style="list-style-type: none"> 1. Web media separates labels by gaps, holes, or notches <div data-bbox="857 541 1209 926">  </div> 2. Black mark media uses pre-printed black marks on the back side of the media to indicate label separations <div data-bbox="857 1056 1209 1140">  </div> 3. Perforated media has perforations that allow the labels or tags to be separated from each other easily in addition to position control marks, notches or label gaps <div data-bbox="857 1297 1209 1392">  </div>
<p>Non-continuous fanfold media</p>		<p>Fanfold media is folded in a zigzag pattern. Fanfold media can have the same label separations as non-continuous roll media. The separations would fall on or near the folds.</p> <p>This type of media uses black marks or notches to track media format positioning.</p>

Table 2 Types of Media Roll and Fanfold Media (Continued)

Media type	How it looks	Description
Continuous roll media		Continuous roll media does not have gaps or typically holes, notches, or black marks either to indicate label separations. This allows the image to be printed anywhere on the label. A cutter can be used to cut apart individual labels. With continuous media, use the transmissive (gap) sensor so the printer can detect when the media runs out.

ZPL Configuration

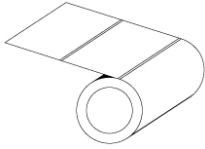
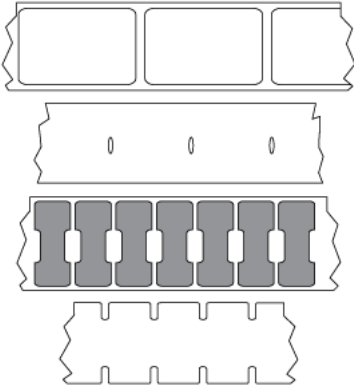
This section details how to configure and manage one or more printers and prompt the printer to print a Configuration Status printout or printer memory printouts using the ZPL programming language.

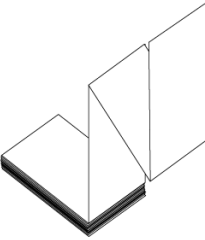
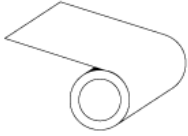
ZPL Printer Configuration

A printer that supports ZPL allows you to change printer settings dynamically to enable fast, first-label-out printing.

When established one time, persistent printer parameters are retained for use for subsequent printing. They remain in effect until:

- they are changed by subsequent commands,
- printer settings or one or more parameters are reset to their factory defaults, or
- printer power is cycled.

The `^JUU` ZPL Configuration Update command saves and restores printer configurations to initialize or re-initialize the printer with pre-configured settings.

- To retain all current persistent settings after a power cycle or printer reset, send the `^JUS` command to the printer.



NOTE: ZPL stores all parameters when this command is issued. The legacy EPL programming language (supported by this printer) changes and saves individual commands immediately.

- To restore the last saved values to the printer, use the `^JUR` command.

Most printer settings are shared between ZPL and EPL. For example, changing the speed setting with EPL will also change the speed set for ZPL operations. The modified EPL setting will persist even after a power cycle or reset issued by either printer language.

The Printer Configuration report is useful list of operating parameters, sensor settings, and printer status. You can print one using the steps in [Testing Printing with the Configuration Report](#) on page 59 or through the Zebra Setup Utilities or ZebraDesigner Windows driver.

ZPL Printer Configuration Format and Reusable Files

To set up and manage multiple printers that need the same configuration, create a printer configuration programming file to download to all of them. The other option is to use ZebraNet Bridge to clone many printers with the same file that you used to configure one printer.

For information on creating a programming file to send to one or more printers, see the ZPL programmer's guide and the [Configuration Setting to Command Cross-reference](#) on page 169. You can use Windows

Notepad as the text editor to create programming files and Zebra Setup Utilities to send these files to the printer(s).

The figure below shows the basic recommended structure for a ZPL programming configuration file. This simple format makes the file reusable.

Figure 16 Configuration Parameter Format Structure

^XA — Start Format Command

Format Commands are order sensitive

- a) General Print and command settings
- b) Media handling and behaviors
- c) Media print size

^JUS command to save

^XZ — End Format Command

Configuration Setting to Command Cross-reference

The Printer Configuration Report provides a listing of a majority of the configurations settings that can be set by ZPL command.

Figure 17 Configuration Report

```

PRINTER CONFIGURATION
Zebra Technologies
ZTC ZD410-300dpi ZPL
60J1B3200190

+20.0..... DARKNESS
LOW..... DARKNESS SWITCH
4.0 IPS..... PRINT SPEED
+000..... TEAR OFF
TEAR OFF..... PRINT MODE
MARK..... MEDIA TYPE
REFLECTIVE..... SENSOR SELECT
640..... PRINT WIDTH
1104..... LABEL LENGTH
38.0IN 889MM..... MAXIMUM LENGTH
MAINT. OFF..... EARLY WARNING
NOT CONNECTED..... USB COMM.
AUTO..... SER COMM. MODE
9600..... BRUD
8 BITS..... DATA BITS
NONE..... PARITY
XON/XOFF..... HOST HANDSHAKE
NONE..... PROTOCOL
NORML. MODE..... COMMUNICATIONS
<^> ZCH..... CONTROL PREFIX
<^> SEH..... FORMAT PREFIX
<.> ZCH..... DELIMITER CHAR
ZPL II..... ZPL MODE
INACTIVE..... COMMAND OVERRIDE
NO MOTION..... MEDIA POWER UP
FEED..... HEAD CLOSE
DEFAULT..... BACKFEED
+000..... LABEL TOP
+0000..... LEF POSITION
DISABLED..... REPRINT MODE
042..... WEB SENSOR
058..... MEDIA SENSOR
128..... TAKE LABEL
070..... MARK SENSOR
004..... MARK MED SENSOR
000..... TRANS GAIN
100..... TRANS LED
088..... MARK GAIN
058..... MARK LED
DPCSWFXM..... MODES ENABLED
MODES DISABLED
3.0..... RESOLUTION
3.0..... LINK-OS VERSION
V77.1B.14Z <- FIRMWARE
1.3..... XML SCHEMA
6.5.0 0.515..... HARDWARE ID
9182..... RI RAM
65536K..... E: ONBOARD FLASH
NONE..... FORMAT CONVERT
ENABLED..... IDLE DISPLAY
01/01/70..... RTC DATE
01:11..... RTC TIME
DISABLED..... ZBI
2.1..... ZBI VERSION
READY..... ZBI STATUS
312 LABELS..... NONRESET CNTR
312 LABELS..... RESET CNTR1
312 LABELS..... RESET CNTR2
1.593 IN..... NONRESET CNTR
1.593 IN..... RESET CNTR1
1.593 IN..... RESET CNTR2
4.047 CM..... NONRESET CNTR
4.047 CM..... RESET CNTR1
4.047 CM..... RESET CNTR2
EMPTY..... SLOT 1
0..... MASS STORAGE COUNT
0..... HID COUNT
OFF..... USB HOST LOCK OUT
FIRMWARE IN THIS PRINTER IS COPYRIGHTED
    
```

Table 3 ZPL Commands and Configuration Report Callout Cross-Reference

Command	Listing name	Description
~SD	DARKNESS	Default: 10.0
—	DARKNESS SWITCH	LOW, MEDIUM, or HIGH
^PR	PRINT SPEED	Default: 152.4 mm/s / 6 IPS (max.) - 203 dpi 101.6 mm/s / 4 IPS (max.) - 300 dpi
~TA	TEAR OFF	Default: +000
^MN	MEDIA TYPE	Default: GAP/NOTCH
	SENSOR SELECT	Default: AUTO (^MNA - Auto-Detect)
^MT	PRINT METHOD	THERMAL-TRANS or DIRECT-THERMAL

Table 3 ZPL Commands and Configuration Report Callout Cross-Reference (Continued)

Command	Listing name	Description
^PW	PRINT WIDTH	Default: 448 (dots for 203 dpi) or 640 (dots for 300 dpi)
^LL	LABEL LENGTH	Default: 1225 (dots) (dynamically updated while printing)
^ML	MAXIMUM LENGTH	Default: 39.0IN 989MM
—	USB COMM.	Connection Status: Connected / Not Connected
^SCa	BAUD	Default: 9600
^SC,b	DATA BITS	Default: 8 BITS
^SC,,c	PARITY	Default: NONE
^SC,,,,e	HOST HANDSHAKE	Default: AUTO
^SC,,,,,f	PROTOCOL	Default: NONE
— SGD —**	COMMUNICATIONS	Default: NORMAL MODE
	SER COMM. MODE	Default: AUTO
^CT / ~CT	CONTROL CHAR	Default: <~> 7EH
^CC / ~CC	COMMAND CHAR	Default: <^> 5EH
^CD / ~CD	DELIM./CHAR	Default: <, > 2CH
^SZ	ZPL MODE	Default: ZPL II
— SGD —**	COMMAND OVERRIDE	Default: INACTIVE
^Mfa	MEDIA POWER UP	Default: NO MOTION
^MF,b	HEAD CLOSE	Default: FEED
~JS	BACKFEED	Default: DEFAULT
^LT	LABEL TOP	Default: +000
^LS	LEFT POSITION	Default: +0000
~JD / ~JE	HEXDUMP	Default: NO (~JE)
	REPRINT MODE	Default: DISABLED

Items in this table marked with ** in this table are not supported with a ZPL command. They use the Set/Get/Do command. See the ZPL Programming Guide for details. See also the `device.command_override.xxxxx` in this guide available from zebra.com/support.

From this point in the Configuration Report listing, it lists sensor settings and values used to troubleshoot sensor and media operations. These are typically used by Zebra Tech Support to diagnose printer problems.

ZPL Configuration

The configuration settings shown below appear after the TAKE LABEL sensor value on the Configuration Report. These listings represent printer features that are seldom changed from their defaults or provide only status information.

Table 4 ZPL Commands and Configuration Receipt Callout Cross-Reference

Command	Listing name	Description
^MP	MODES ENABLED	Default: CWF (see ^MP command)
	MODES DISABLED	No default set.
^JM	RESOLUTION	Default: 448 8/mm (203 dpi); 640 8/mm (300 dpi)
—	FIRMWARE	Lists ZPL firmware version.
—	XML SCHEMA	1.3
—	HARDWARE ID	Lists firmware boot-block version.
	LINK-OS VERSION	
—	CONFIGURATION	CUSTOMIZED (after first use)
—	RAM	2104k..... R:
—	ONBOARD FLASH	6144k..... E:
^MU	FORMAT CONVERT	NONE
	RTC DATE	Date displayed.
	RTC TIME	Time displayed.
^JI / ~JI	ZBI	DISABLED (requires key to enable)
	ZBI VERSION	2.1 (displayed if installed)
	ZBI STATUS	READY
^JH ^MA ~RO	LAST CLEANED	X,XXX IN
	HEAD USAGE	X,XXX IN
	TOTAL USAGE	X,XXX IN
	RESET CNTR1	X,XXX IN
	RESET CNTR2	X,XXX IN
	NONRESET CNTR0 (1, 2)	X,XXX IN
	RESET CNTR1	X,XXX IN
	RESET CNTR2	X,XXX IN
	SLOT1	EMPTY / SERIAL / WIRED
	MASS STORAGE COUNT	0
	HID COUNT	0

Table 4 ZPL Commands and Configuration Receipt Callout Cross-Reference (Continued)

Command	Listing name	Description
	USB HOST LOCK OUT	OFF/ON
—	SERIAL NUMBER	XXXXXXXXXXXX
^JH	EARLY WARNING	MAINT. OFF

The printer has the ability to set a command or a group of commands once for all receipts (or labels) that follow. Those settings will remain in effect until they are changed by subsequent commands, the printer is reset, or you restore factory defaults.

Printer Memory Management and Related Status Reports

To help you manage printer resources, the printer supports a variety of format commands. They are very similar to the old DOS commands like DIR (directory listing) and DEL (delete file) and they enable you to manage memory, transfer objects between memory areas (such as import and export), object naming, and printing various status reports.

The most common reports are available for printing using the Zebra Setup Utilities and ZebraDesigner Windows driver.

It is optimal to issue a single command for processing in this format for ease of reuse.

^XA — Start Format Command

Format Commands are order sensitive

- a) General Print and command settings
- b) Media handling and behaviors
- c) Media print size

^ **JUS** command to save

^XZ — End Format Command

Several of the commands that help import and export objects, and manage and report on memory are control (~) commands. They do not need have to be within a format (form) and will be processed immediately upon receipt by the printer whether they are in a format or not.

ZPL Programming for Memory Management

ZPL has various printer memory locations that are used to run the printer, assemble the print image, store formats (forms), graphics, fonts and configuration settings.

- ZPL treats formats (forms), fonts, and graphics like files; and memory locations like disk drives in the DOS operating system environment:
 - Memory object naming (of up to 16 alphanumeric characters followed by a three alphanumeric character file extension such as 123456789ABCDEF.TTF)
 - Legacy ZPL printers with version 60.13 firmware and earlier can only use the 8.3 file name format instead of today's 16.3 file name format.
- Allows moving objects between memory locations and deleting objects.
- Supports DOS directory style file list reports as printouts or status to the host.

- Allows the use of wildcards (*) to access files,

Table 5 Object Management and Status Report Commands

Command	Name	Description
^WD	Print directory label	Prints a list of objects and resident barcodes and fonts in all addressable memory locations,.
~WC	Print configuration label	Prints a printer configuration status label. Same as FEED button () mode one-flash routine.
^ID	Object delete	Deletes objects from printer memory,.
^TO	Transfer object	Used to copy an object or group of objects from one memory area to another.
^CM	Change memory letter designation	Reassigns a letter designation to a printer memory area.
^JB	Initialize flash memory	Similar to formatting a disk. Erases all objects from the specified memory locations B : or E : .
~JB	Reset optional memory	Similar to formatting a disk. Erases all objects from the B : memory (factory option).
~DY	Download objects	Downloads and installs wide variety of printer usable programming objects: fonts (OpenType and TrueType), graphics, and other object data types. Use ZebraNet Bridge for downloading graphics and fonts to the printer.
~DG	Download graphic	Downloads an ASCII Hex representation of a graphic image that is used by ZebraDesigner (label creation application) for graphics handling.
^FL	Font linking	Appends secondary TrueType font or fonts to the primary TrueType font to add glyphs (characters).
^LF	List font links	Prints a list of the linked fonts.
^CW	Font identifier	Assigns a single alphanumeric character as an alias to a font stored in memory.



IMPORTANT: Some factory-installed ZPL fonts in your printer cannot be copied, cloned, or restored to your printer by reloading or updating firmware. If these license restricted ZPL fonts are removed by an explicit ZPL object delete command, they must be repurchased and then reinstalled using a font activation and installation utility. EPL fonts do not have this restriction.

